

NEC

HIGH DEFINITION RECEIVER / RECORDER

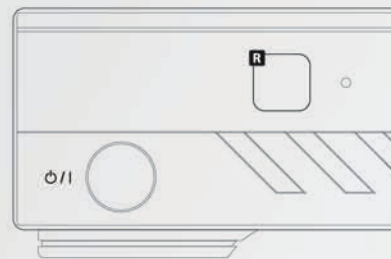

Model : NHD-3000PVR

NEC

HIGH DEFINITION RECEIVER / RECORDER

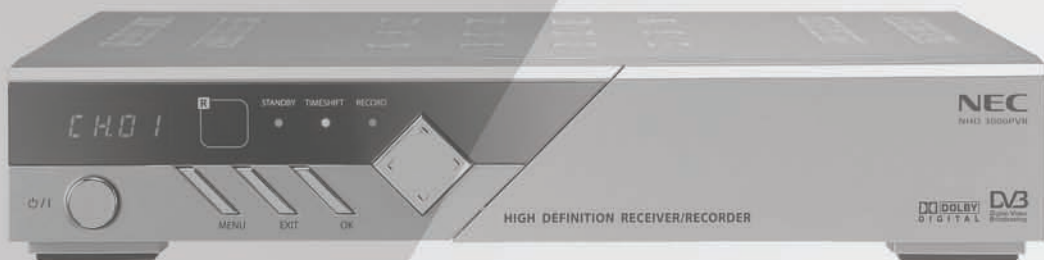

Model : NHD-3000PVR

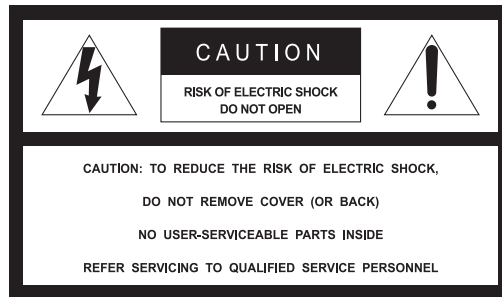

The lightning flash with arrowhead symbol, within an equilateral triangle, is intended to alert the user to the presence of uninsulated "dangerous voltage" within the product's enclosure that may be of sufficient magnitude to constitute a risk of electric shock to persons.



The exclamation point within an equilateral triangle is intended to alert the user to the presence of important operating and maintenance (servicing) instructions in the literature accompanying the appliance.

WARNING : To prevent fire or shock hazard, do not expose this appliance to rain or moisture.

Important Safeguard

CAUTION : The appliance is not intended for use by young children / infirm persons without supervision.

Young children should be supervised to ensure that they do not play with the appliance.

To prevent electric shock do not use this (polarized) plug with a receptacle or other outlet unless the blades can be fully inserted to prevent blade exposure.

Change or modification not expressly approved by the party responsible for compliance could void the factory warranty.

The apparatus shall not be exposed to dripping or splashing and that no objects filled with liquids, such as vases, shall be placed on the apparatus.

The socket-outlet shall be installed near the equipment and shall be easily accessible.

1. Read Instructions : All the safety and operating instructions should be read before the product is operated.
2. Retain Instructions : The safety and operating instructions should be retained for future reference.
3. Heed Warnings : All warnings on the product and in the operating instructions should be adhered to.
4. Follow Instructions : All operation and use instructions should be followed.
5. Cleaning : Unplug this product from the wall outlet before cleaning. Do not use liquid cleaners or aerosol cleaner. Use a damp cloth for cleaning.
6. Attachment : Do not use attachments not recommended by the product manufacturer as they may cause hazards.

01 Warnings

7. **Water and Moisture** : Do not use the product near water - for example, near a bath tub, wash bowl, kitchen sink, or laundry tub ; in a wet basement ; or near a swimming pool ; and the like.
8. **Accessories** : Do not place this product on an unstable table. The product may fall, causing serious injury to a child or adult, and serious damage to the product. Use only with a table recommended by the manufacturer, or sold with the product. Any mounting of the product should follow the manufacturer's instructions, and should use a mounting accessory recommended by the manufacturer.
9. A product and cart combination should be moved with care. Quick stops, excessive force, and uneven surface may cause the product and cart combination to overturn. Please refer to picture on the right.

10. **Ventilation-Slot and openings in the cabinet** are provided for ventilation and to ensure reliable operation of the product and to protect it from overheating, and these openings must not be blocked or covered. The openings should never be blocked by placing the product on a bed, sofa, rug, or other similar surface. This product should not be placed in a built-in installation such as a bookcase or rack unless proper ventilation is provided or the manufacturer's instructions have been adhered to.
11. **Power Sources** : This product should be operated only from the type of power source indicated on the marking label. If you are not sure of the type of power supply to your home, please contact NEC Service Centre or NEC Pro Care Centre. For products intended to operate from battery power, or other sources, refer to the operating instructions.
12. **Polarization** : This product may be equipped with a polarized alternating-current line plug. This plug will fit into the power outlet only one way. This is a safety feature. Do not defeat the safety purpose of the polarized plug.
13. **Power-Cord Protection** : Power-supply cords should be routed so that they are not likely to be walked on or pinched by items placed upon or against them, paying particular attention to cords at plugs, convenience receptacles, and the point where they exit from the product.
14. **Lighting** : For added protection for this product during a lighting storm, or when it is left unattended and unused for long periods of time, unplug it from the wall outlet and disconnect the antenna or cable system. This will prevent damage to the product due to lighting and power-line surges.
15. **Power Lines** : An outside antenna system should not be located in the vicinity or overhead power lines or other electric light or power circuits, or where it can fall into such power lines or circuits. When installing an outside antenna system, extreme care should be taken to keep from touching such power lines or circuits as contact with them might be fatal.
16. **Overloading** : Do not overload wall outlets, extension cords, or integral convenience receptacles as this can result in a risk of fire or electric shock.
17. **Object and Liquid Entry** : Never push objects of any kind into this product through opening as they may touch dangerous voltage points or short-out parts that could result in a fire or electric shock. Never spill liquid of any kind on the product.
18. **Servicing** : Do not attempt to service this product yourself as opening or removing covers may expose you to dangerous voltage or other hazards. Refer all servicing to qualified service personnel.
19. **Damage Requiring Service** : Unplug this product from the wall outlet and refer servicing to qualified service personnel under the following conditions :
 - a) When the power-supply cord or plug is damaged.

- b) If liquid has been spilled, or objects have fallen into the product.
 - c) If the product has been exposed to rain or water.
 - d) If the product does not operate normally by following the operating instructions. Adjust only those controls that are covered by the operating instructions as an importer adjustment of other controls may result in damage and will often require extensive work by a qualified technician to restore the product to its normal operation.
 - e) If the product has been dropped or damaged in any way.
 - f) When the product exhibits a distinct change in performance-this indicate a need for service.
20. Replacement Parts - When replacement parts are required, be sure the service technician has used replacement parts specified by the manufacturer or have the same characteristics as the original part. Unauthorized substitutions may result in fire, electric shock, or other hazards.
21. Safety Check : Upon completion of any service or repairs to this product, ask the service technician to perform safety checks to determine that the product is in proper operating condition.
22. Heat : The product should be situated away from heat sources such as radiators, heat registers, stoves, or other products (including amplifiers) that produce heat.
23. RF Interference : Do not operate a mobile phone in close proximity, as this may cause picture and sound breakup and damage to main parts.

About the internal hard disk drive

The internal hard disk drive (HDD) is a fragile piece of equipment. Please use the recorder following the guidelines below to protect against possible HDD failure or to protect against accidental loss.

1. Do not move the recorder while it is on.
2. Install and use the recorder on a stable, level surface.
3. Do not block the top cover vent holes.
4. Do not use the recorder where it is excessively hot or humid places, or where places are subject to sudden changes in temperature. Sudden changes in temperature can cause condensation to form inside the recorder. This can be a cause of HDD failure.
5. While the recorder is switched on, do not unplug from the wall socket or switch the electricity off from the breaker switch.
6. Do not move the recorder immediately after switching it off. If you need to move the recorder, please follow the steps below:
 - a) After the message 'P-OFF' (POWER OFF) is shown in the display, wait at least two(2) minutes.
 - b) Unplug from the wall socket.
 - c) Move the recorder.
7. If there's a power failure while the recorder is on, there is a chance that some data on the HDD will be lost.
8. The HDD is very delicate. If used improperly or in an unsuitable environment, it is possible that the HDD will fail after a few years of usage. Signs of problems include playback unexpectedly freezing and noticeable block noise (mosaic) in the picture. However, sometimes there will be no warning signs of HDD failure. If the HDD fails, no playback of recorded material will be possible. In this case, it will be necessary to replace the HDD unit.

02 Table of Contents

01. Warnings	1
02. Table of Contents	4
03. Supplied Accessories	6
04. Controls	
Front Panel Controls and LEDs	7
Rear Panel Connectors	8
Battery Installation for Remote Control	10
05. Installation	
Antenna Input	11
Connection to Digital TV (YPbPr)	12
Connection to Digital TV (RGB/HV)	13
Connection to RGB PC Monitor	14
Connection to Digital TV (HDMI/DVI)	15
Connection to HDMI/DVI PC Monitor	16
Connection to Analog TV (Composite/S-Video)	17
Connection to Digital Audio Amplifier	18
06. Basic Operation	
Remote Control	19
07. On Screen Display	
Channel Information	22
Channel Guide (EPG)	23
Channel Status	24
Channel List	25
Timeshift Control	26
Record Control (Dual Recording)	27
Timer Record List	28
Program List	29
Program List (Rename)	30
Playback Control	31
EDIT Control (Repeat, Cut, Split)	32
Closed Caption	33

Teletext	34
PIP Control	35
08. Channel	
Channel Edit	36
Channel Scan	37
Manual Scan	38
Channel Sorting	39
Channel Duplication	40
Parental Rating	41
09. Audio/Video	
HDMI Video	42
HDMI Audio	43
Monitor Setup	44
Digital Audio Out	45
PIP Size	46
Vol. Control	47
10. PVR Manager	
Program List	48
Skip Time	49
HDD Sleep Time	50
HDD Format	51
11. System	
Opacity	52
Time Zone	53
Daylight Saving	54
Sleep Timer	55
New Password	56
Factory Default	57
About	58
12. Specifications	59

※ Manufactured under license from Dolby Laboratories. Dolby and the double-D symbol are trademarks of Dolby Laboratories.

03 Supplied Accessories

◆ Make sure the following accessories are provided with product.

1. Remote Control

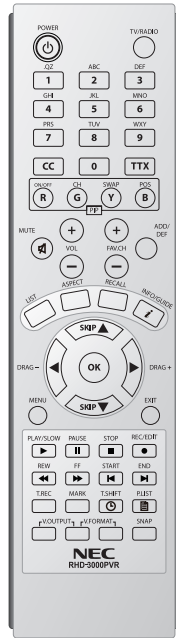

2. Batteries (size AAA)

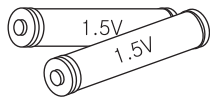

3. User's Guide

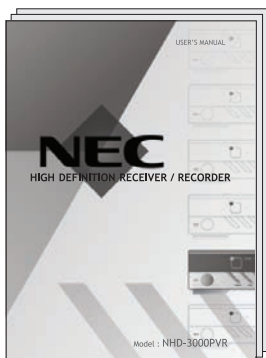

4. Component Video Cable

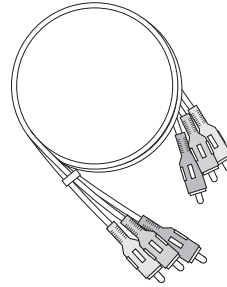

5. Audio Cable(L/R)

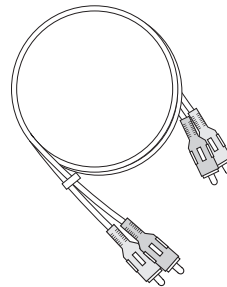

6.HDMI Cable

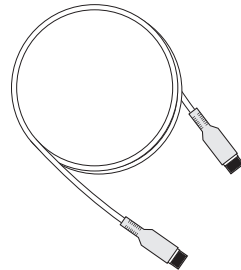

7. RF Loop Cable

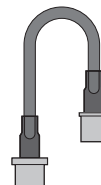

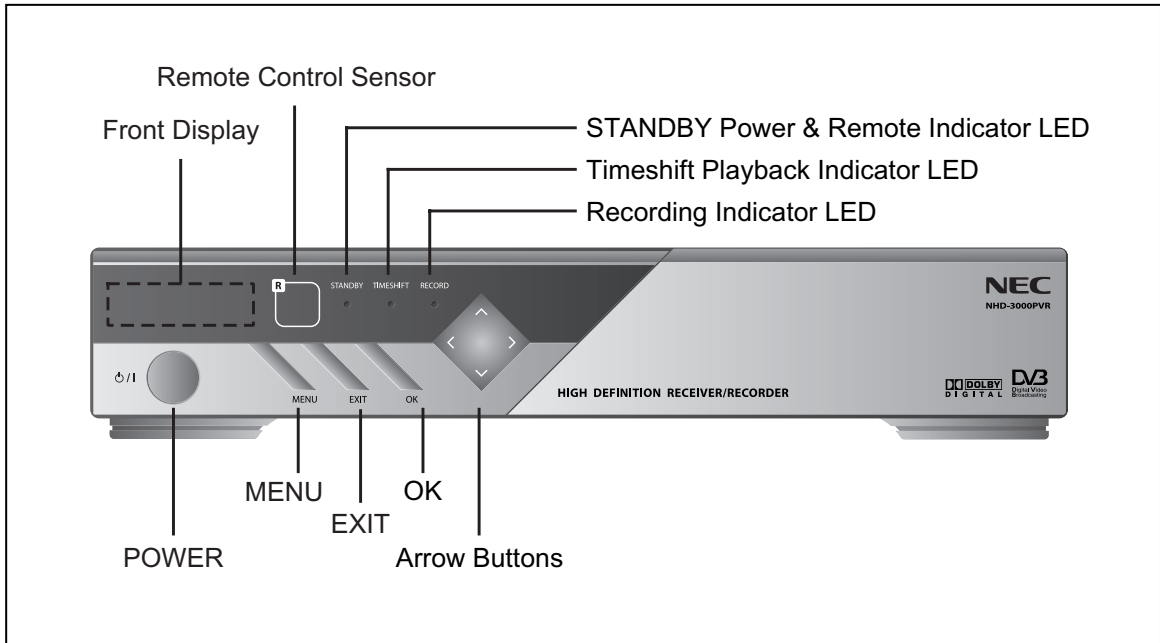

Front Side

Front Display

- Power On** Channel number is displayed.
C100 means digital channel number is 100.
A200 means radio channel number is 200.
- Power Off** Clock is displayed.

LED Indicators

- STANDBY** STANDBY Power & Remote Sensor Indicator LED.
During the period from STANDBY to ON condition, the STANDBY LED will be flashing.
- TIMESHIFT** Timeshift Playback Indicator LED.
- RECORD** Record Indicator LED.

Buttons

- Power** Turns the unit on or off.
- Menu** Display or exit the on screen menu.
- Exit** Switch back to the previous menu screen that was displayed.
- OK** If the main menu is displayed, pressing the **OK** button will activate the highlighted MENU option.
- Arrow Buttons** Allows you to navigate on-screen menus and to adjust the system settings and preferences.

04 Rear Panel Connectors

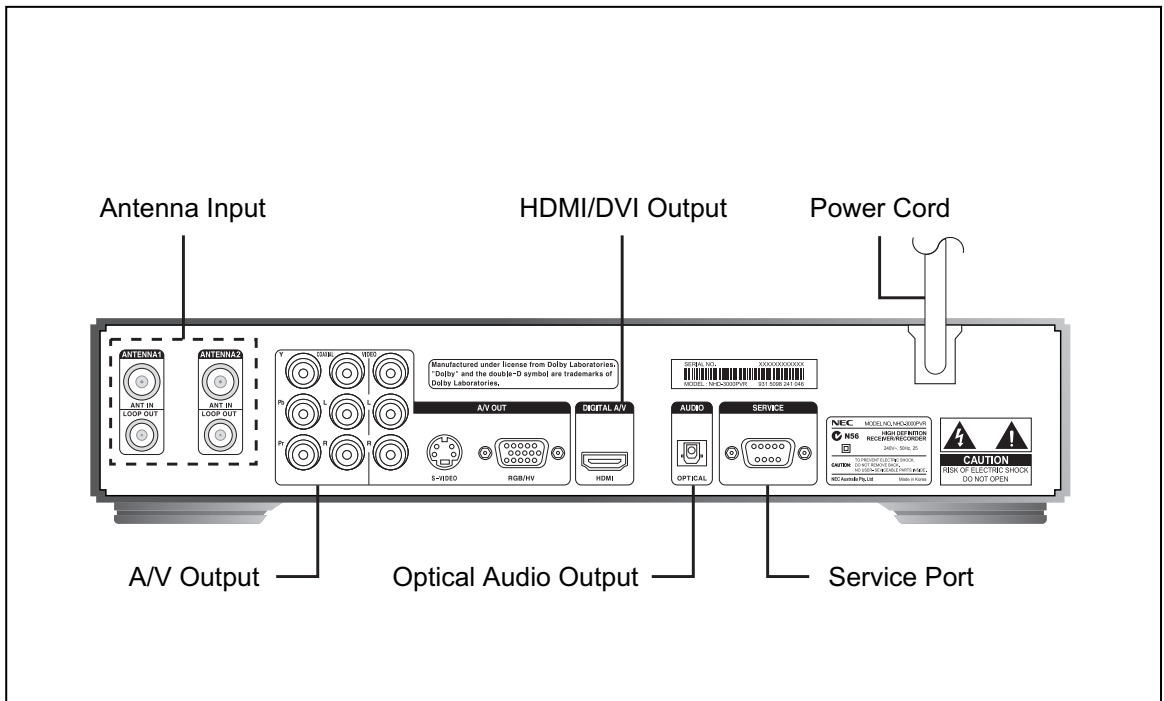

Rear Side

◆ Note. Connection of input/output connector in rear panel should be done while power is OFF.

Power Cord

Connect to the AC power (AC 240 ~ 250V / 50Hz).

Antenna Input

Connect the cable from an off-air TV antenna to Antenna1 input.
Connect Antenna1 loop out to Antenna2 input with RF loop cable.

A/V Output

The 'A/V output' consists of the followings :

Y, Pb, Pr	: Component video output (576i, 576p, 720p, 1080i)
RGB/HV	: RGB, PC monitor output (576p, 720p, 1080i)
HDMI/DVI	: HDMI/DVI output (576p, 720p, 1080i)
Video or S-Video	: Composite video or S-Video output (576i)
L, R	: Analog audio output
COAXIAL	: Digital audio output (Coaxial)
OPTICAL	: Digital audio output (Optical)

Service Port

The service port is for maintenance and software upgrade in the future.

04 Battery Installation for Remote Control

- ◆ Remove the battery cover and install batteries like the diagram below.

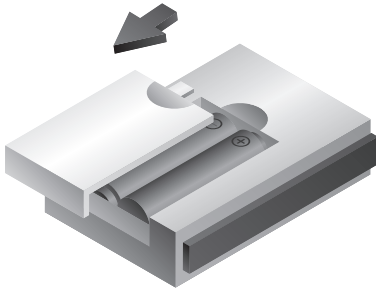

1. Unlatch the battery compartment cover on the back of remote control.

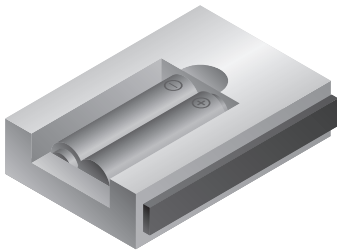

2. Insert 2 AAA batteries as shown, making sure the + and - ends of each battery line up with the corresponding marks in the battery compartment.

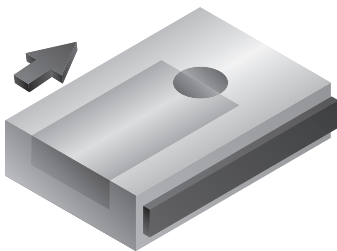

3. Snap the cover back to the remote control.

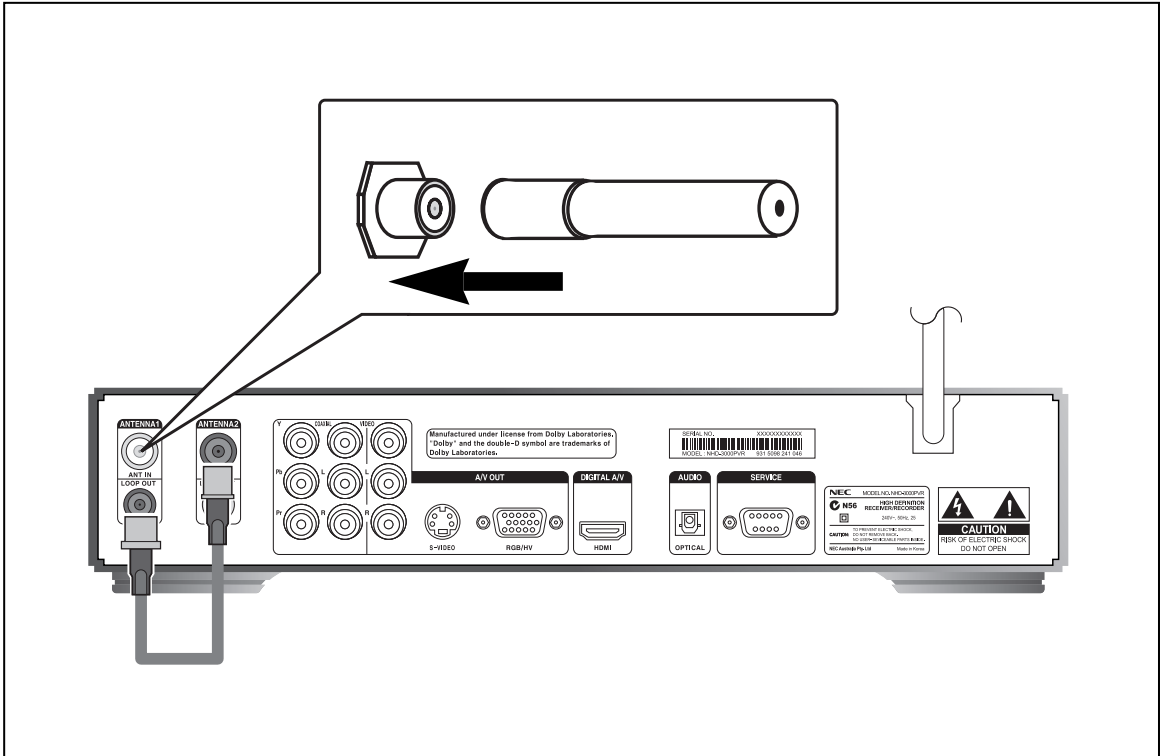

THE RF LOOP CABLE MUST BE CONNECTED, OTHERWISE THE UNIT WILL NOT BE ABLE TO TUNE.

Connecting Antenna

Connect the antenna or RF cable wire directly to ANTENNA1 IN and connect ANTENNA1 Loop Out to ANTENNA2 Input by using RF loop cable.

◆ NOTE

- The STB(Set Top Box) should be unplugged before connecting antenna. (Power OFF mode)
- The RF OUT from the tuner will only work when the unit turns on. It will not give RF OUT during STANDBY mode.

05 Connection to Digital TV (YPbPr)

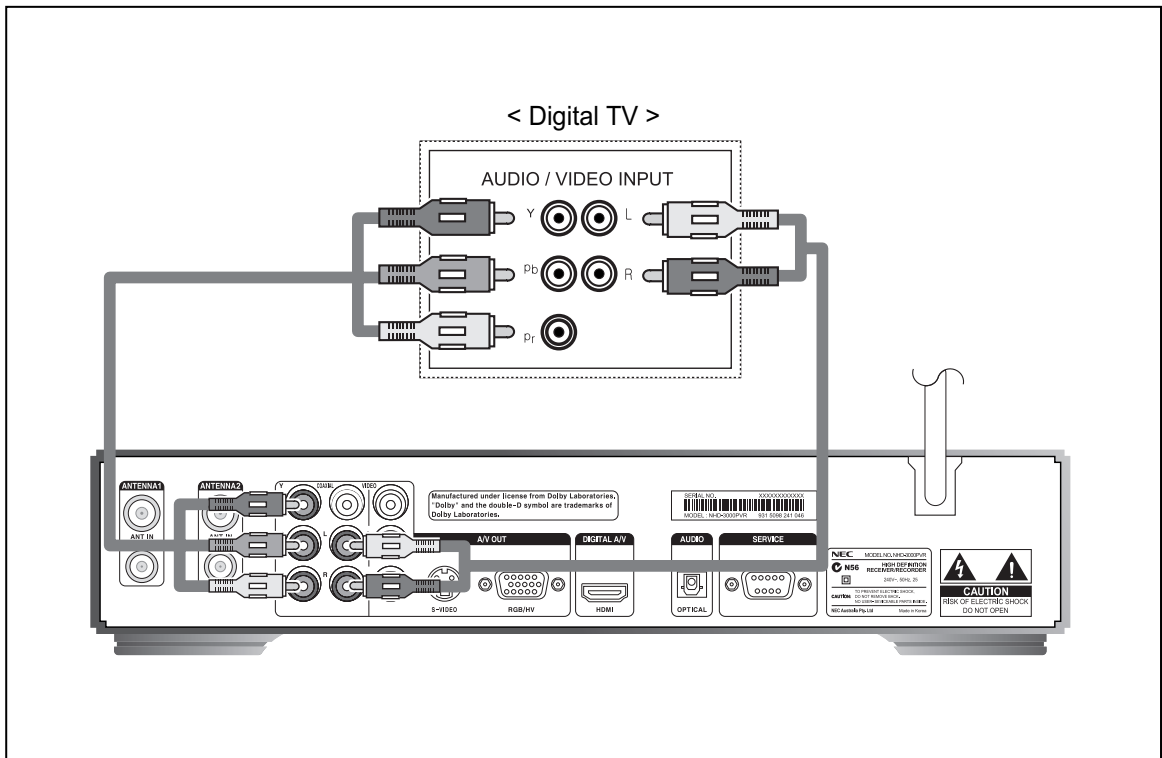

Connect the Video Cables

Connect a video cable between the Component video output (Y : Green, Pb : Blue, Pr : Red) jacks of the STB (Set Top Box) and the Component input jacks on the Digital TV according to corresponding colour. On the Video Out Mode, select YPbPr as Video Output Type and select one of 1080i, 720p, 576p, 576i as Video Output Resolution according to your digital TV.

◆ NOTE

- By pressing the remote, **V-OUTPUT** (2 buttons), you will be able to change the output 'YPbPr' and 'RGB'. (YPbPr selection is usually used for Component Input, while RGB selection is usually used for PC/HDMI Input)
- By pressing the remote, **V-FORMAT** (2 buttons), you will be able to change the format '1080i', '720p', '576p', '576i'.

Connect the Audio Cables

Connect an audio cable between the L/R Audio output jacks of the STB and the L/R Audio input jacks of the digital TV or digital audio amplifier. (Refer to page 18)

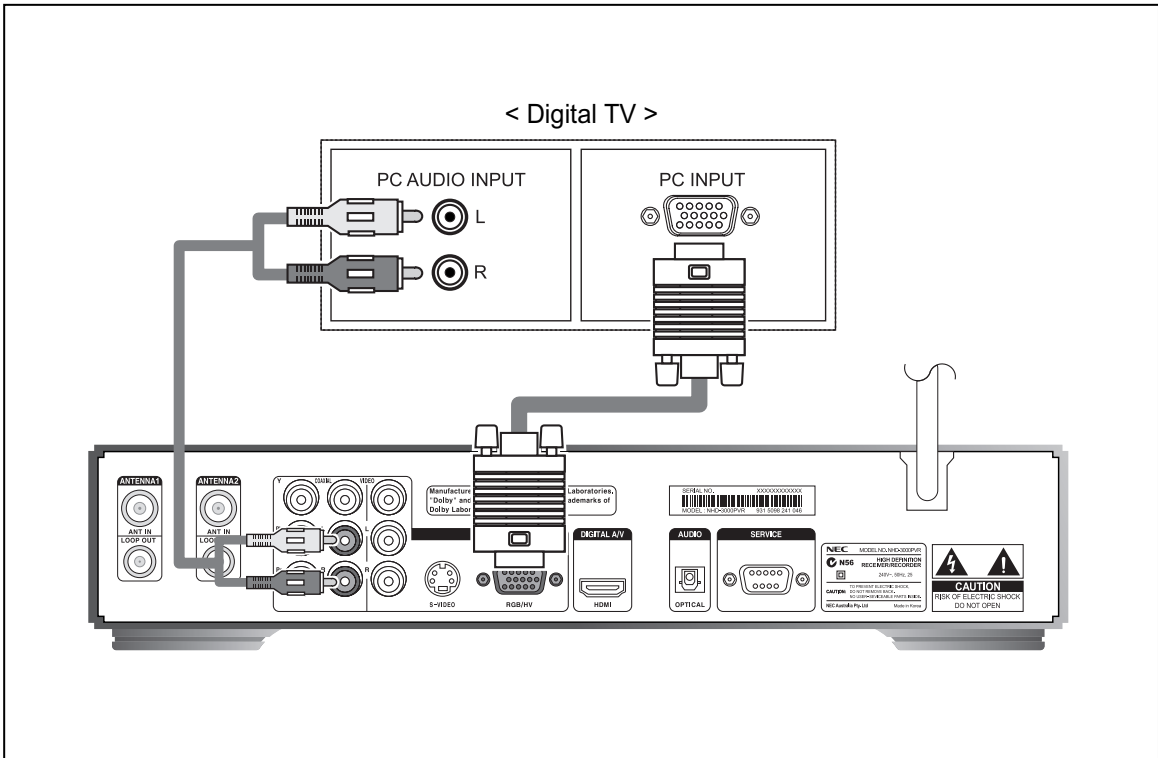

Connect the Video Cables

Connect the RGB/HV output jack of the STB to the RGB input jack of the PC RGB input on the digital TV. In regard to the Video Out Mode, select RGB as Video Output Type and select one of 1080i, 720p, 576p as Video Resolution according to your digital TV.

◆ NOTE

- By pressing the remote, **V-OUTPUT** (2 buttons), you will be able to change the output 'YPbPr' and 'RGB'. (YPbPr selection is usually used for Component Input, while RGB selection is usually used for PC/HDMI Input)
- By pressing the remote, **V-FORMAT** (2 buttons), you will be able to change the format '1080i', '720p', '576p', '576i'.

Connect the Audio Cables

Connect an audio cable between the L/R Audio output jacks of the STB and the L/R PC Audio input jacks of the digital TV or digital audio amplifier. (Refer to page 18)

05 Connection to RGB PC Monitor

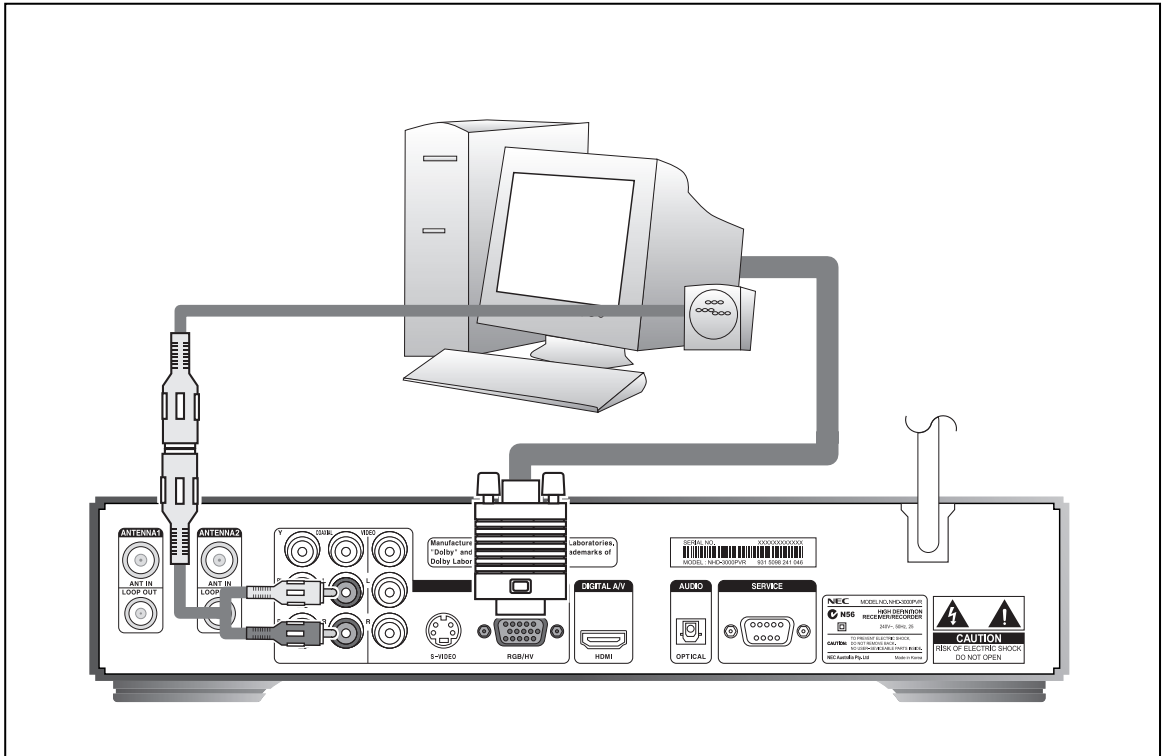

Connect the Video Cables

Connect RGB/HV video output jack of the STB to the RGB jack of the PC monitor. In regard to the Video Out Mode, select RGB as Video Output Type and select one of 1080i, 720p, 576p according to Video Output Resolution of your PC monitor.

◆ NOTE

- By pressing the remote, **V-OUTPUT** (2 buttons), you will be able to change the output 'YPbPr' and 'RGB'. (YPbPr selection is usually used for Component Input, while RGB selection is usually used for PC/HDMI Input)
- By pressing the remote, **V-FORMAT** (2 buttons), you will be able to change the format '1080i', '720p', '576p', '576i'.

Connect the Audio Cables

Connect an audio cable between the L/R Audio output jacks of the STB and the external speakers that contain a sound amp. (Purchase separate jacks for PC speakers.)

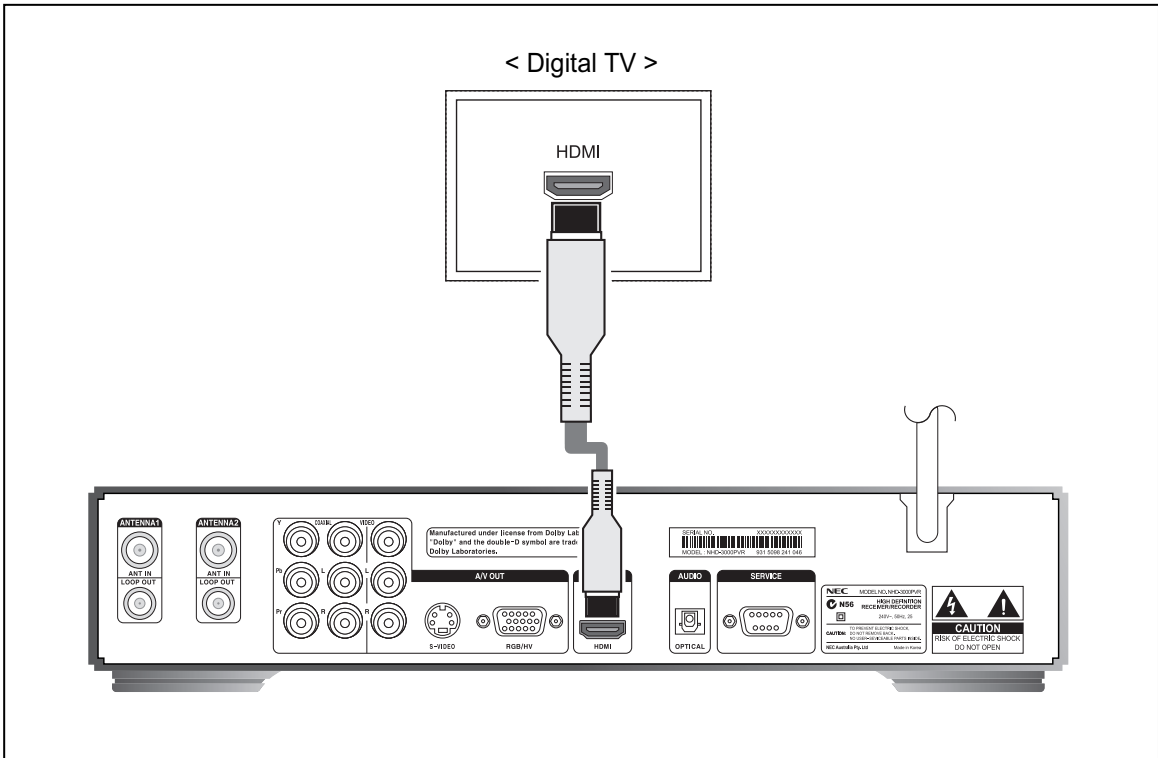

Connect the HDMI Cable

Connect the HDMI/DVI output jack of the STB to the HDMI input jack of the digital TV. In regard to the Video Out Mode, select one of 1080i, 720p, 576p as Video Resolution according to your digital TV.

◆ NOTE

- By pressing the remote, **V-OUTPUT** (2 buttons), you will be able to change the output 'YPbPr' and 'RGB'. (YPbPr selection is usually used for Component Input, while RGB selection is usually used for PC/HDMI Input)
- By pressing the remote, **V-FORMAT** (2 buttons), you will be able to change the format '1080i', '720p', '576p', '576i'.
- When you connect using HDMI, depending on your digital TV, you can change the value of video timing by going to the HDMI VIDEO selection at the MENU. The two selections available are :
 - HDMI means the value of video timing is setup for HDMI
 - YPbPr/RGB means the value of video timing is setup for YPbPr/RGB
- You can view the difference between the two selections above by pressing 'MARK'. If you see OUTPUT, and there is a letter 'H' in the beginning (eg: OUTPUT: H1080), it means HDMI is selected. If you see OUTPUT, (eg: OUTPUT: 1080), it means normal YPbPr/RGB is selected.

05 Connection to HDMI/DVI PC Monitor

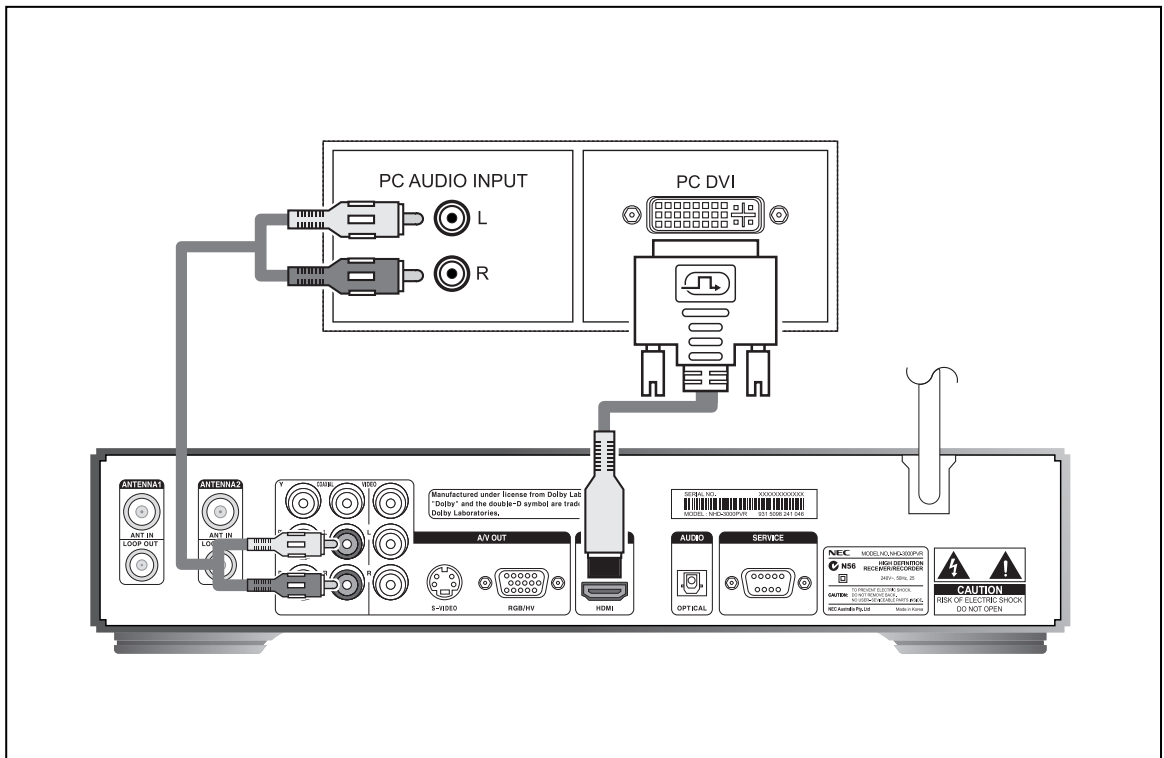

Connect the Video Cables

Connect HDMI/DVI jack of the STB to the HDMI/DVI jack of the PC monitor. In regard to the Video Out Mode, select one of 1080i, 720p, 576p according to Video Output Resolution of your monitor. (Purchase HDMI-to-DVI adapter.)

◆ NOTE

- By pressing the remote, **V-OUTPUT** (2 buttons), you will be able to change the output 'YPbPr' and 'RGB'. (YPbPr selection is usually used for Component Input, while RGB selection is usually used for PC/HDMI Input)
- By pressing the remote, **V-FORMAT** (2 buttons), you will be able to change the format '1080i', '720p', '576p', '576i'.

Connect the Audio Cables

Connect an audio cable between the L/R AUDIO output jacks of the STB and the external speakers that contain a sound amp. (Purchase separate jacks for PC speakers.)

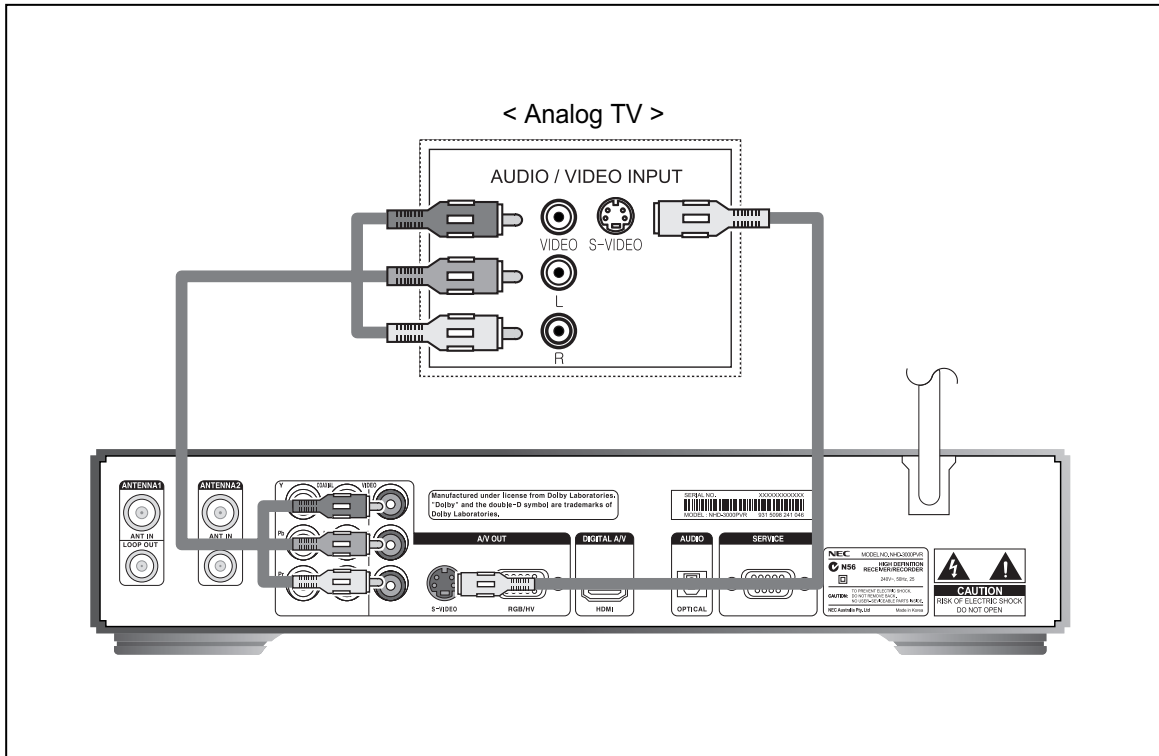

If you use Composite/S-VIDEO connection, you must select 576i format. Otherwise all of the OSD (On Screen Display) will not function, including MENU, MARK, etc.

Connect the Video Cables

Connect a composite cable between the Video output jack of the STB and the Video input jack of the analog TV. Or, connect an S-Video cable between the S-Video output jack of the STB and the S-Video input jack of the analog TV. You can connect either composite Video or S-Video cable. When connecting using Composite Video or S-Video, please ensure to select 576i of the set top box, by pressing **V.FORMAT** button on the remote.

◆ NOTE

- By pressing the remote, **V-OUTPUT** (2 buttons), you will be able to change the output 'YPbPr' and 'RGB'. (YPbPr selection is usually used for Component Input, while RGB selection is usually used for PC/HDMI Input)
- By pressing the remote, **V-FORMAT** (2 buttons), you will be able to change the format '1080i', '720p', '576p', '576i'.

Connect the Audio Cables

Connect an audio cable between the L/R Audio output jacks of the STB and the L/R Audio input jacks of the analog TV.

05 Connection to Digital Audio Amplifier

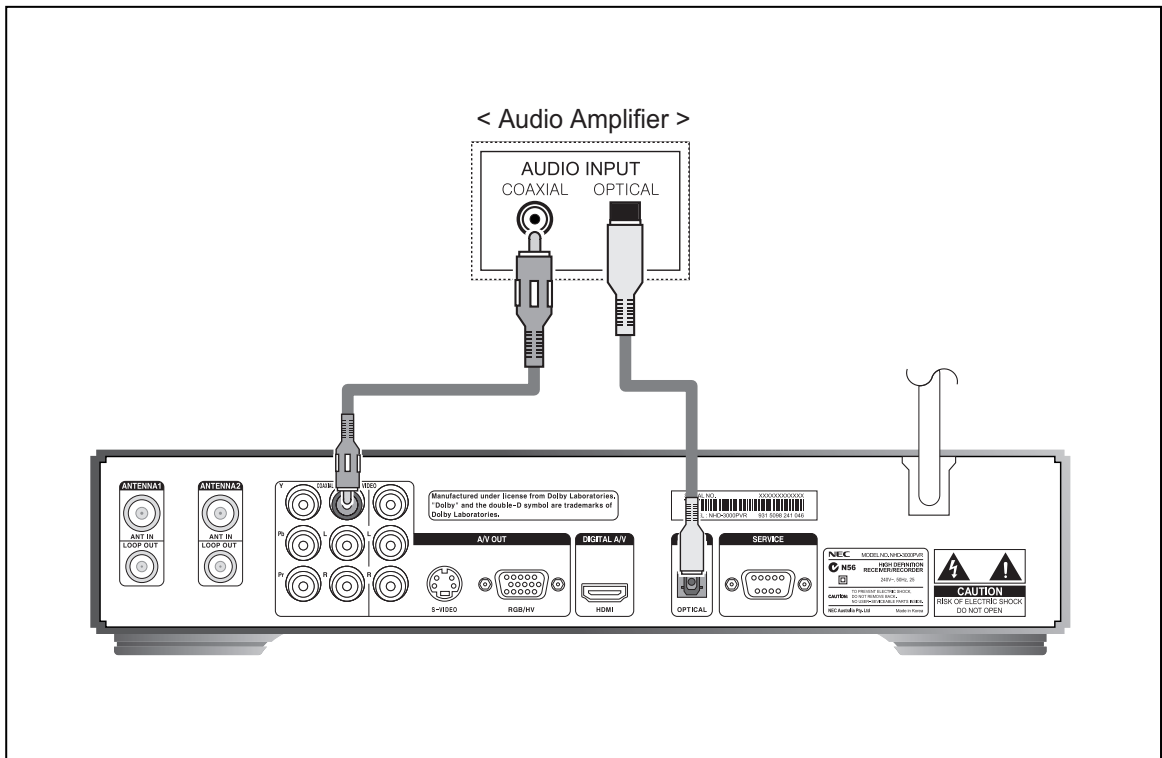

Connect the Digital Audio Output







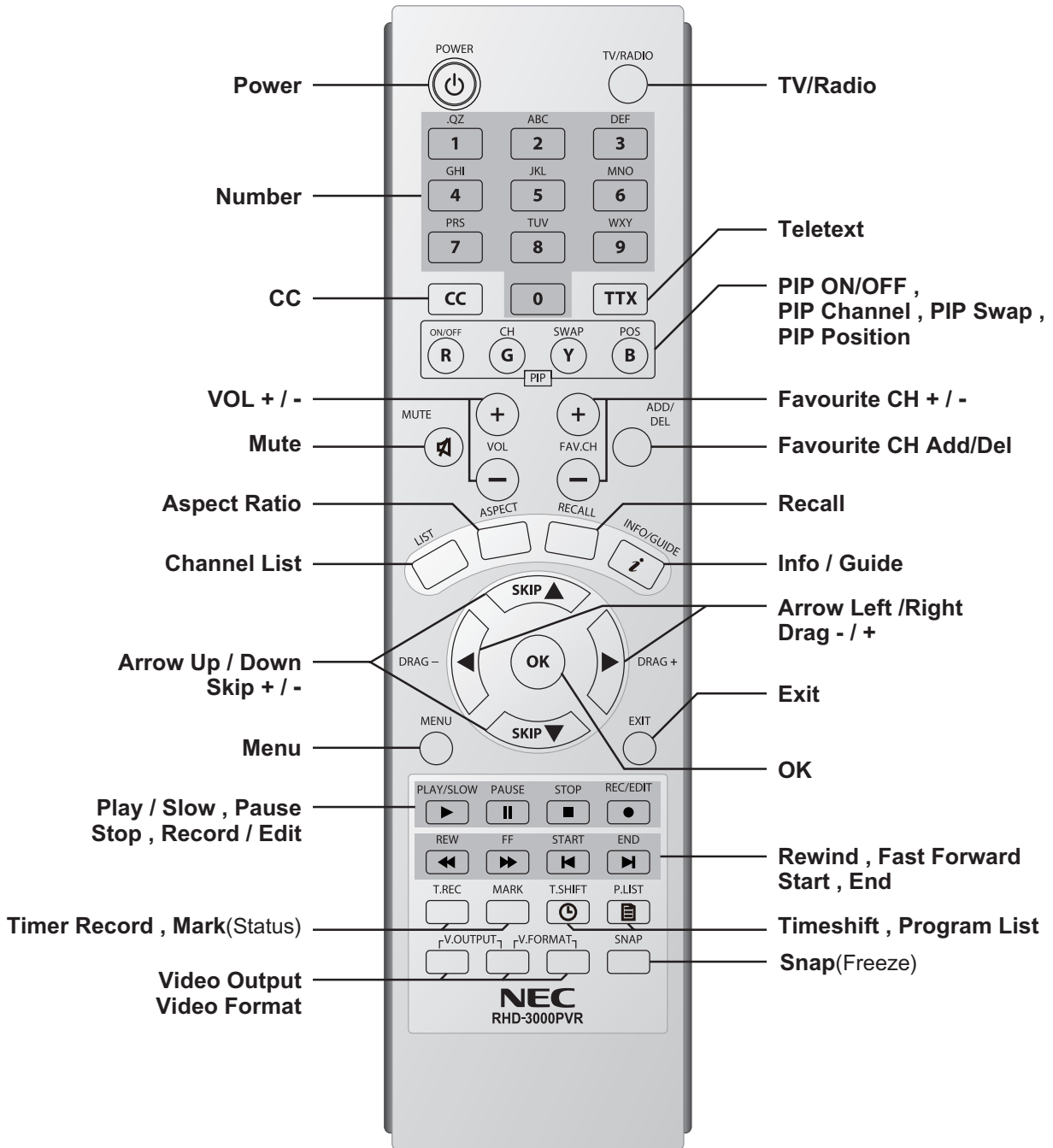



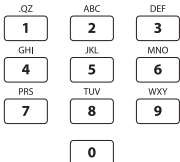

Connect audio cables from the OPTICAL or COAXIAL digital audio output jacks of the STB to the OPTICAL or COAXIAL digital audio input jacks of the digital audio decoder or the amplifier. Do not connect the coaxial and optical audio output simultaneously and be sure to connect either optical or coaxial cable to avoid any damage to digital audio decoder or amplifier that may occur. It is recommended to use OPTICAL connection if a digital audio decoder or amplifier provides both OPTICAL and COAXIAL input jacks.

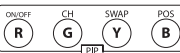
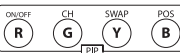
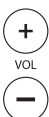

















◆ NOTE

- When you connect using HDMI cable, the digital audio in the TV is detected. So if it detects PCM, then the Digital OUT will be at PCM too. If it detects Dolby Digital, then the Digital OUT will be at Dolby Digital too.
- There are 3 options on HDMI AUDIO in the menu.
 - i AUTO : If the broadcaster is broadcasting PCM/MPEG, the Digital OUT will be PCM. If the broadcaster is broadcasting Dolby Digital, the Digital OUT will be Dolby Digital.
 - ii PCM : Whatever the broadcaster is broadcasting (PCM/MPEG or Dolby Digital), the Digital OUT will be at PCM.
 - iii DISABLE: Select this, in order to have Digital Audio OUT in Dolby Digital for using external amplifier at below conditions.
 - The TV digital audio support only PCM, and HDMI cable is used.
 - The broadcaster is broadcasting Dolby Digital.



06 Remote Control (Cont.)

Button	Description
	Press to turn the power ON or OFF.
	Select TV or Radio Channel.
	Channel Number Buttons from #0 to #9. Press to directly tune to a particular channel.
	Press to turn Closed Captions on / off.
	Press to turn Teletext on / off.
	Usage in Teletext mode RED, GREEN:Page Up/Down, Yellow:Freeze Teletext, BLUE:Unfreeze Teletext
	Usage for PIP functions ON/OFF : Enable or disable PIP display. CH : Select channel for PIP display . SWAP : Exchange channels between main display and PIP display. POS : Move PIP Position of PIP display.
	Press to control the volume. (if volume control is on)
	By pressing the MUTE button, you can turn sound on or off.
	Press to change a channel in memorized favourite channels.
	Press to add or delete a current channel in favourite channels.
	Press to display the channel list and select one channel from the list.
	Press to change the screen format to one of Full,Letter/Piller Box, Hor.Zoom, Ver. Zoom or HV Zoom.
	Press to go to previous channel.
	Press once to display information on current program and box settings. Please refer to the page 22 for detailed information. Press twice to display Channel Guide. (EPG)

Button	Description
	<p>< ▲▼ > : Channel Up/Down or Menu navigation in up or down direction.</p> <p>< ◀▶ > : Menu navigation in left or right direction.</p> <p>< OK > : Selection.</p> <p>< Skip +/- > : Forward or backward skip.</p> <p>< Drag +/- > : Move to the location where you want to playback.</p>
<p>MENU</p> 	<p>Press to display or exit the on-screen Menu.</p>
<p>EXIT</p> 	<p>Press to switch back to the previous Menu screen that was displayed.</p>
<p>PLAY/SLOW</p> 	<p>Starts playback. Press PLAY/SLOW during playback then the unit will go into Slow mode.</p>
<p>PAUSE</p> 	<p>Pauses playback or start timeshift.</p>
<p>STOP</p> 	<p>Stops playback or recording.</p>
<p>REC/EDIT</p> 	<p>Instant record in viewing program. Press the REC/EDIT during playback then edit sub-menu will appear.</p>
<p>REW</p> 	<p>Rewinds at 8 different speeds up to 128 times the speed of normal playback.</p>
<p>FF</p> 	<p>Fast Forwards at 7 different speeds up to 128 times the speed of normal playback.</p>
<p>START</p> 	<p>Returns to the first position of current playback.</p>
<p>END</p> 	<p>Moves to the end point of a program during playback or returns to the current TV program live broadcast during pause timeshift.</p>
<p>T.REC</p> 	<p>Display the timer record list menu.</p>
<p>MARK</p> 	<p>This button has two functions:</p> <ul style="list-style-type: none"> · It will display the channel STATUS of the HD receiver. · Give a mark during playback. (Repeat/Cut/Split)
<p>T.SHIFT</p> 	<p>Activates pause live tv/playback (timeshift) for live TV.</p>
<p>PLIST</p> 	<p>Displays the recorded program list.</p>
<p>SNAP</p> 	<p>Press to freeze the picture (To return to normal operation, press any button)</p>
<p>V.OUTPUT V.FORMAT</p> 	<p>Press to change the output video format from one of resolutions, such as 1080i, 720p, 576p or 576i (576i is not supported In HDMI output)</p>
<p>V.OUTPUT V.FORMAT</p> 	<p>Press to change the video output to RGB or YPbPr.</p>

07 Channel Information

◆ Press the **INFO** button to display the following screen.

The diagram shows a television screen displaying channel information. At the top, there is a status bar with a signal strength indicator (1), the channel number '20' (2), 'HD/Dolby D' (3), and the current time '18:13' (4). Below this, the service provider 'ABC ABC HDTV' (5) and recording status 'TS REC#1 REC#2' (10, 11) are shown. The main program name 'Now British Isles : A Natural History' (6) and its next program 'Next Gardening Australia' (7) are displayed in a large font. On the right side, the parental guidance rating 'G' (8) and timeshift playback status 'G' (9) are visible. Arrows from the numbered callouts point to these specific elements.

1. RF Signal Strength
Indicates the signal strength of the selected channel.

2. Channel Number
Current Logical Channel Number.

3. A/V Information
Indicates Video Resolution and Audio type.

4. Current Time
Displays current time.

5. Service Provider and Service Name
Displays the service provider and service name.

6. Current Program
Displays current program name of current channel.

7. Next Program
Displays next program name of current channel.

8. Parental Guidance Rating

9. Timeshift Playback
Displays when timeshift on.

10. REC#1
Displays when recording by use of Tuner#1

11. REC#2
Displays when recording by use of Tuner#2

※ The channel information menu automatically closes in a few seconds. To exit immediately, press the **EXIT** button.

◆ Press **INFO/GUIDE** button twice to select Channel Guide (EPG).

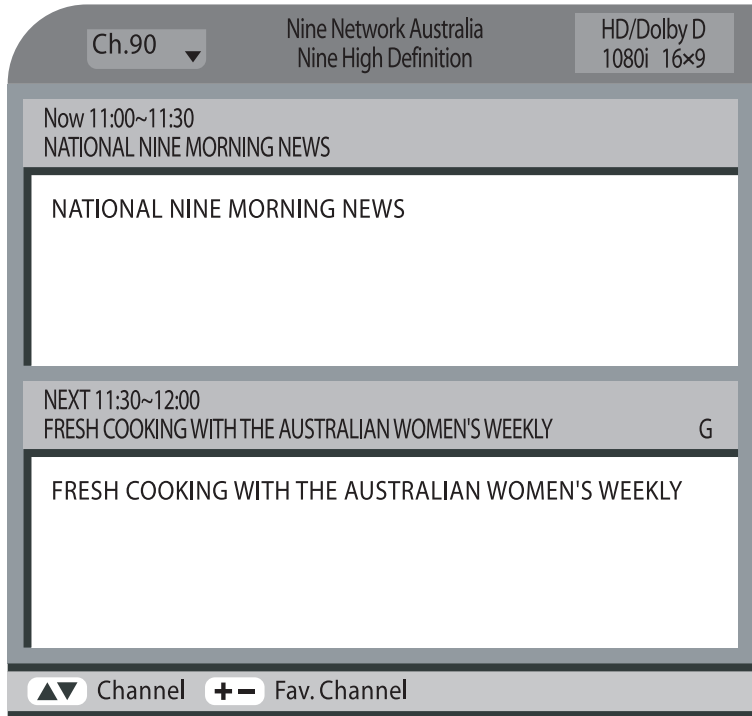

1. Press **INFO/GUIDE** button twice.
2. Press ▲, ▼, **FAV.CH(+/-)** buttons to change the channel.

※ To exit immediately, press the **EXIT** button.

07 Channel Status

◆ Press **MARK**(STATUS) button to display current channel status and information.

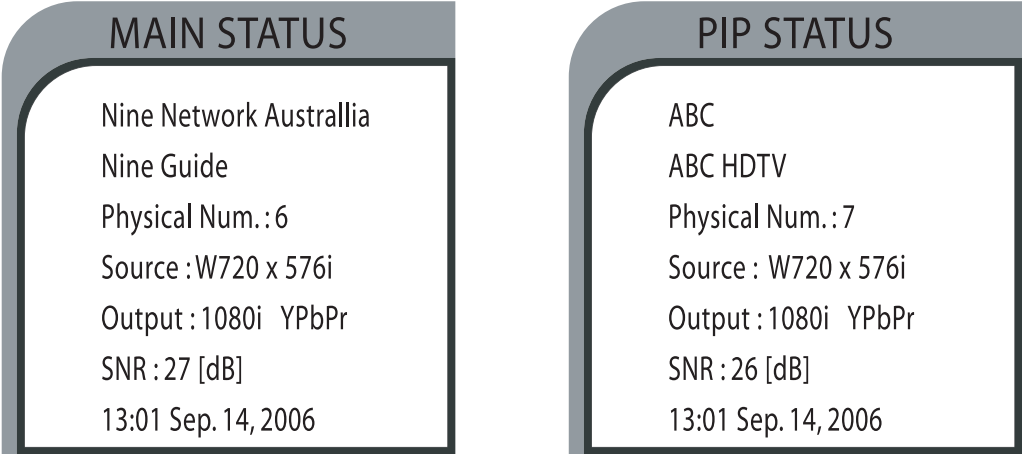

MAIN STATUS	PIP STATUS
Nine Network Australlia	ABC
Nine Guide	ABC HDTV
Physical Num.: 6	Physical Num.: 7
Source : W720 x 576i	Source : W720 x 576i
Output : 1080i YPbPr	Output : 1080i YPbPr
SNR : 27 [dB]	SNR : 26 [dB]
13:01 Sep. 14, 2006	13:01 Sep. 14, 2006

Press **MARK**(STATUS) button to display main channel status and information. It displays service provider name, service provider title, physical channel number, source video format, output video format and signal quality.

- Press **MARK**(STATUS) button twice, then you can see PIP channel status.

※ Mark function is activated when play bar OSD is on.
※ To exit immediately, press the **EXIT** button.

◆ Press **LIST** button to select channel on Channel List menu.

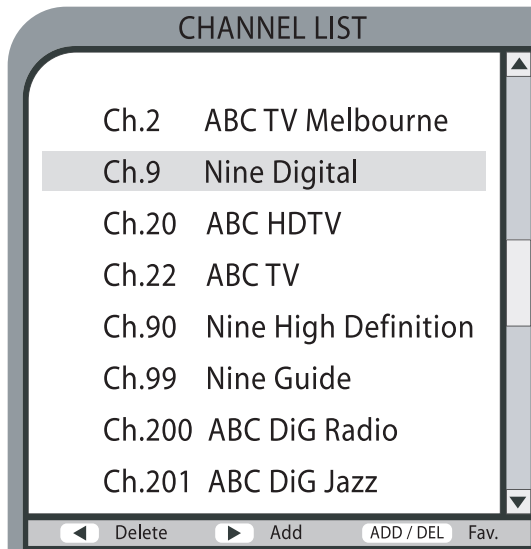

❖ For channel change, add or delete

1. Press **LIST** or **OK** button.

2. Press **▲, ▼** button to highlight 'Channel List'.

3. Press **OK** button to tune.

4. Press **▶** button to add channels to 'Channel List' or press **◀** button to delete channels to 'Channel List'. If channel is added to 'Channel List', the colour of the channel number is changed to white. If a channel is deleted from 'Channel List', the colour of the channel number is changed to black.

5. Press **ADD/DEL** button to add a channel to the Favourite Channel List, and press again to delete the channel from the Favourite Channel List. If a channel is added to Favourite Channel List, the colour of the channel number is changed to white and a check is marked in front of the channel number. If a channel is deleted from Favourite Channel List, The check mark as a favourite channel indicator is removed.

※ The **OK** button can be used for seeing Channel List menu

※ If you see the channel list by pressing **OK** button, the channel list menu will be disappeared after channel changing.

※ If you see the channel list by pressing **LIST** or **OK** button, deleted channels are not shown in channel list.

※ To exit immediately, press the **EXIT** button.

07 Timeshift Control

◆ Press **T.SHIFT** button to start timeshift.

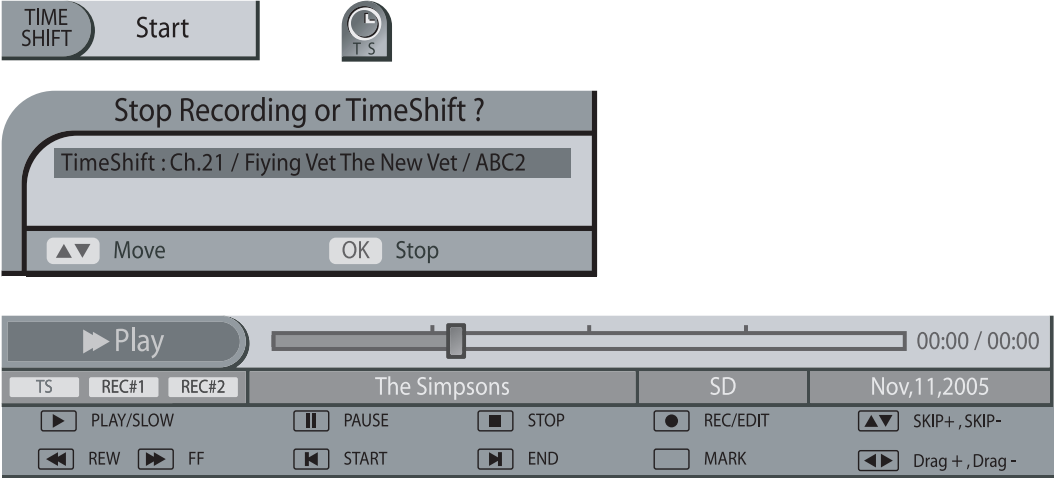

Start Timeshift : Press **PAUSE** button or **T.SHIFT** button. The timeshift logo will be displayed during timeshift.

Stop Timeshift : Press **STOP**[■] button (follow the instruction from OSD), then press **OK** button.

Available functions during Timeshift :

- 1.Starting point of timeshift : **START**[◀] button.
- 2.Ending point of timeshift : **END**[▶] button.
- 3.SCAN : **FF**[▶▶] button or **REW**[◀◀] button.
- 4.Slow Motion : Press **PLAY/SLOW**[▶] button during playback state.
- 5.Smart Skip : **SKIP▲** or **SKIP▼** button. (Skip time can be set in MENU, see page 49)

※ When Timeshift is ON, you can see a logo on the left (🕒). If you want to remove this logo, press **EXIT** button.

※ Timeshift has to be at least about 1 minute recording.

※ Timeshift runs about 1 hour.

※ Timeshift is unavailable during recording.

※ If recording is started, the timeshift will be automatically terminated.

※ Edit function is unavailable during timeshift.

※ Playback of recorded program doesn't work during timeshift. Stop timeshift for playback recorded program.

※ Channel change is unavailable during timeshift. Stop timeshift for Channel change.

※ In case of starting timeshift using **T.SHIFT** button, it takes 4~10 seconds starting timeshift, and display blinks shortly as starting.

※ To stop current channel recording intermediatly press **STOP** button, then press **OK** button.

※ If timeshift function are executed for 12 hours without any interruption by user, it will automatically quit and go to live mode.

※ Since timeshift runs on the last 1 hour, the captured picture at P.LIST will be different if timeshift has run more than one hour.

◆ Press **REC/EDIT** button to select recording time.



This NHD-3000PVR has two digital tuners in it. One can be displayed as MAIN picture, while another one can be displayed as PIP (Picture in Picture). This is a very convenient feature that enables you to:

- Record two channels simultaneously
- Record one channel while watching another channel
- Watching two channels simultaneously

When you do the first recording, by pressing **REC/EDIT** button, it will automatically go to TUNER#1 (PIP). This means the MAIN picture will be copied to PIP picture automatically. This is a feature that enables you to watch other TV channels, while the PIP (TUNER#1) is doing a record.

Current channel Record :

- For current channel record, press **REC/EDIT** button, select record time and press **OK** button. Then current channel record begins.
- If the recording time is less than one minute, it is not recorded.

Dual Record :

- Two current channel programs can be recorded simultaneously using **REC / EDIT** button.
- Dual record of one timer record and one current channel record is possible.

Cancel Recording :

- To cancel currently recorded program, press **STOP** button, then **OK** button. If the currently recorded program is due to timer record the relevant item in timer record list is also deleted. (DAILY / WEEKLY / ONCE)
- To delete timer record item, press **T.REC** button, and follow instructions described on page 28 .

- ※ Record function cannot be used during playback a recorded program.
- ※ **REC/EDIT** button is for EDIT function during playback a recorded program.
- ※ Main channel can not be changed while recording on Tuner #2.
- ※ PIP channel can not be changed while recording on Tuner #1.
- ※ In Auto Time Zone, receiving broadcasting programs from different Time Zone may result in failed recording due to wrongly set time. In this case, TimeZone and Daylight Saving should be chosen from the zone.
- ※ If a program in main window is recorded, then an image displayed in main window is captured and used as a thumbnail of the recorded program in Program List. If a program in main window is different from the program under record, which may be the case of timer record, then a still image cannot be captured. In this case, there will be no thumbnail for the recorded program at first. However, once the recorded program is played, a still image will be captured and used as a thumbnail of the recorded program.
- ※ Radio Channel is not recordable.
- ※ If the recorded time is less than one minute, the recorded program will not be stored in HDD.

07 Timer Record List

- ◆ Show the Timer Record List.

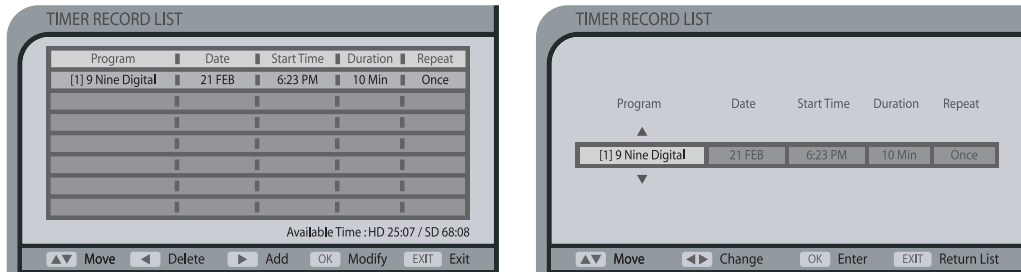

1. Press **T.REC** button.

2. On the Timer Record List, press

- ▲, ▼ button to select a program then press **OK** to display the Edit window. Refer to 3.
- ► button to add new program. Refer to 3.
- ◀ button to delete selected program.

3. On the Edit Window, press ◀, ► button to move to next or previous column then use ▲, ▼ button to change a setting for the selected column. When all is done, press **OK** button to change or add the program.

- Program : Select program.
- Date : Select recording date.
- Start Time : Select recording start time.
- Duration : Select recording duration.
- Repeat : Select repeat option.
 - Once : Record program once.
 - Daily : Record program daily. (Monday ~ Friday)
 - Weekly : Record program every week.

※ The **T.REC** button is recorded at Tuner #1 (PIP).

※ A thumbnail picture will be displayed when **P.LIST** button is pressed. In the beginning of the timer recording, it will first capture the **MAIN** picture, that will be used for the thumbnail. So if the timer recording channel is different from the current **MAIN** picture, the **THUMBNAIL** will display a 'Black' picture when you press **P.LIST** button. However once you playback this in the **MAIN** picture, it will automatically create a thumbnail picture.

※ To cancel currently recorded program, press **STOP** button, then **OK** button. If the currently recorded program is due to timer record the relevant item in timer record list is also deleted. (**DAILY / WEEKLY / ONCE**)

※ To exit immediately, press **T.REC** button.

※ Press **EXIT** button to switch to previous step on the menu screen.

◆ Show the Program List.

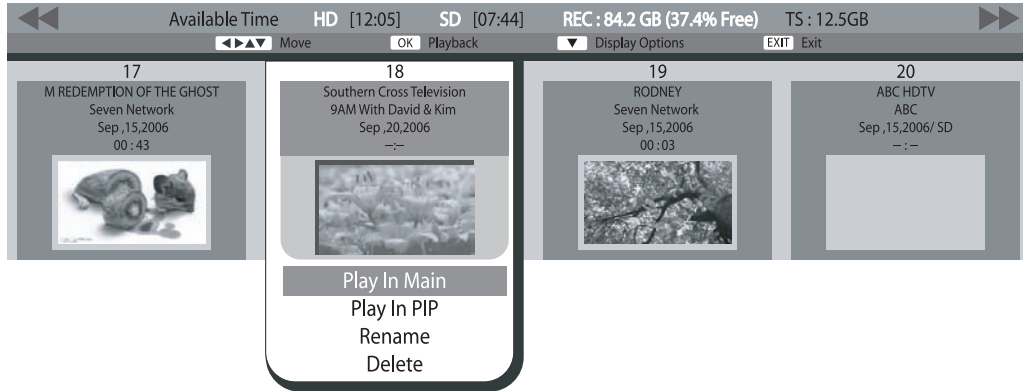

1. Press **P.LIST** button to playback a recorded program.
 2. Use **◀, ▶** button to select a program.
 3. Press **OK** button to playback the selected program.
 4. If new program to be played is same as the previously played one, it will play at the position where you were watching. (Resume function)
 5. Press **▼** button to display options. The options will be displayed as shown above.
 - Play In Main : Play the selected program in main window.
 - Play In PIP : Play the selected program in PIP.
 - Rename : Rename the selected program. (see page 30)
 - Delete : Delete the selected program.
- ※ If a program in main window is recorded, then an image displayed in main window is captured and used as a thumbnail of the recorded program in Program List. If a program in main window is different from the program under record, which may be the case of timer record, then a still image cannot be captured. In this case, there will be no thumbnail for the recorded program at first. However, once the recorded program is played, a still image will be captured and used as a thumbnail of the recorded program.
 - ※ There will be no icon, if a recording is done less than 1 minute.
 - ※ The thumbnail picture will be in BLACK picture if **V.FORMAT** button is changed to another resolution.
 - ※ If you press **SNAP** button while program playback, the thumbnail picture will be changed to that scene.
 - ※ To exit immediately, press **P.LIST** button.
 - ※ Press **EXIT** button to switch to previous step on the menu screen.

07 Program List (Rename)

◆ Show the Program List(Rename).



1. Mode : Capital Letter, Small Letter, Number.
2. Input : Refer to the letters in remote control.

Remote Button	0	1	2	3	4	5	6	7	8	9
Capital Letter		.QZ	ABC	DEF	GHI	JKL	MNO	PRS	TUV	WXY
Small Letter		.qz	abc	def	ghi	jkl	mno	prs	tuv	wxy
Number	0	1	2	3	4	5	6	7	8	9

3. Delete : Delete previous letter or backspace.
4. Next : Move to next letter or insert blank space.
5. Rename : Cannel renaming.
6. Exit : Execute renaming.

◆ Control Playback.

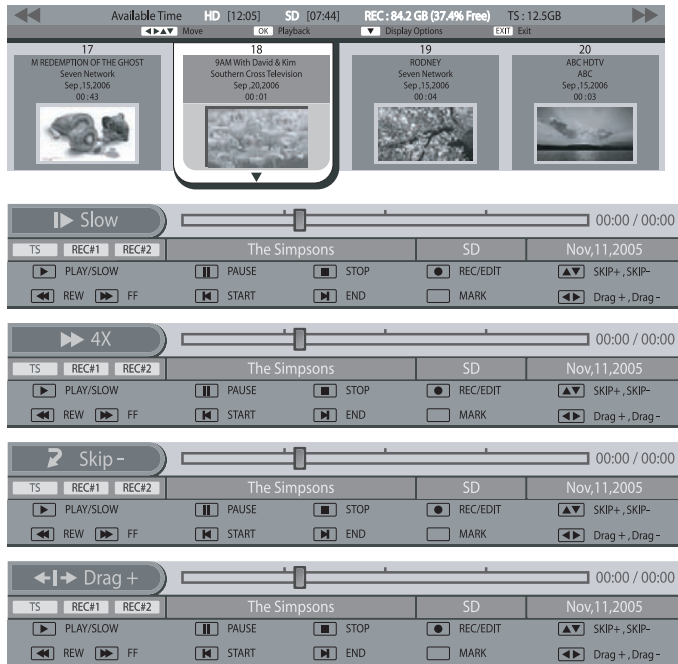

Choose Program List : Press **P.LIST** button or go to MENU and choose a 'Program List'.

Slow Motion : For slow motion press **PLAY/SLOW [▶]** button during normal playback mode. Press **PLAY/SLOW [▶]** button when returning to normal playback mode.

SCAN : For scan mode, press **FF [▶▶]** button or **REW [◀◀]** button. Press **OK** button or **PLAY** button to go to normal playback mode during FF or REW mode.

Smart Skip : **SKIP+**, **SKIP-** button. (Skip time can be set in Menu. See page 49)

Drag : To move to the location where you want to playback, press **DRAG+** or **DRAG-** button and then press **OK** button. While using **DRAG+** or **DRAG-** button, the previous condition such as play, fast forward, rewind, and slow is sustained.

Jump to Starting position : Press **START [◀]** button.

Return to Live broadcasting : Press **END [▶]** or **STOP [■]** button.

- ※ Timeshift is unavailable during Playback. Stop Playback for Timeshift.
- ※ When reaching the end of Program during Playback, Live channel automatically goes on.
- ※ During Playback at PIP, a few functions (Edit, Smart Skip, Drag) are limited. So press **SWAP** button for using Edit, Smart Skip, Drag.

07 EDIT Control (Repeat, Cut, Split)

◆ Control Repeat, Cut & Split.

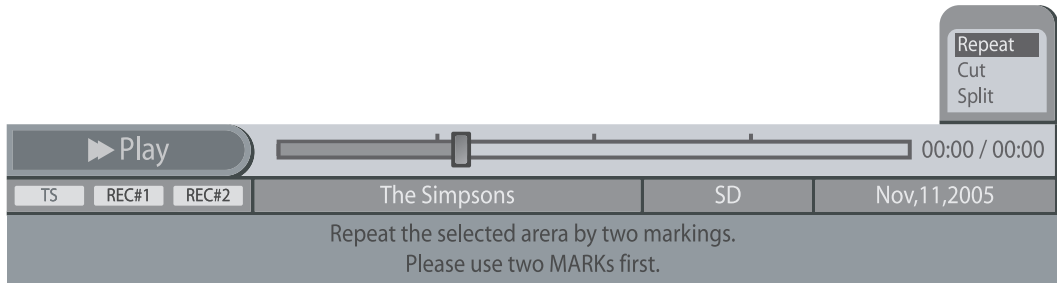

EDIT works only during Playback mode and provide three functions. To enter into EDIT function, press **REC/EDIT** button during playback mode.

MARK has to be used before the operation of these functions. REPEAT/CUT requires two MARKs. SPLIT requires one MARK.

Repeat : Repeat area can be set using **MARK**, **DRAG+**, and **DRAG-** buttons. After setting the repeat area, press **REC/EDIT** button again, then REPEAT, CUT, SPLIT options will shown. Select REPEAT and press **OK** button, then repeat function starts to work.

Repeat cancel : Select REPEAT and press **OK** button again. Then repeat function is canceled and normal playback operation will work. Another way of canceling repeat operation is just pressing **MARK** button or **REC/EDIT** button twice.

Cut : Area to be cut can be set using **MARK**, **DRAG+**, and **DRAG-** buttons. After setting the cut area, press **REC/EDIT** button, select CUT, then press **OK** button. Then selected area will be cut.

Split : Pick a position where you want to split original program into two programs, and press **REC/EDIT** button, select SPLIT, then press **OK** button. Then the original program will be split into two programs at the marked position.

- ※ If a cut needs to be done in the beginning / at the end of the program, it may be used a SPLIT function, then delete the unwanted program.
- ※ If you want to do EDIT operation more precisely, use **DRAG+** and **DRAG-** button during 'slow motion' or 'pause' operation.

◆ Press CC button to turn on/off closed caption.

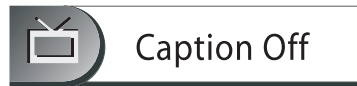

1. To turn on or off caption press **CC** button.
2. Every time **CC** button is pressed, 'Caption On' icon or 'Caption Off' icon will appear in due order.

◆ Press **TTX** button to display current teletext.

100		AUSTEXT 100		Sat 24 Sep 18:32:13	
A U S T E X T M A I N I N D E X					
COPYRIGHT INFORMATION ON 104					
INDEX			INFORMATION		
MAIN INDEX...	100	TODAY & TONIGHT			
NEWS.....	119	SBS	651		
SPORT.....	160	ABC.....	652-656		
FINANCE.....	200	PRIME NSW..	657		
WEATHER.....	300	PRIME VIC..	658		
TAB SERVICE..	500	SEVEN QLD..	659		
GENERAL INFO.	600	SEVEN SYD..	660		
AUSTEXT NEWS.	604	SEVEN MEL..	661		
LOTTERIES....	610	SEVEN BRIS.	662		
GREETINGS....	620	SEVEN PER..	663		
TV PROGRAMS..	650	SEVEN ADL..	664		
KIDS' INDEX..	680	GWN.....	665		
CAPTIONS....	801	TEN.....	666-670		
LET AUSTEXT KEEP YOU UP TO DATE			SOUTHERN		
WITH THE FINANCE WORLD			CROSS.....		
FINANCE REPORTS START PAGE 201			676-677		
-	+	Freeze	Unfreeze		

Press ▲, ▼ button to turn pages up and down, press number 100 to 899 to turn the direct number page.

1. Press **TTX** button to display current teletext.
2. Press ▲ or ▼ button to go to pages up or down.
3. Press number 100 to 899 to go to the numbered page.

Available buttons during TTX mode :

- **RED** button : Page Down
- **GREEN** button : Page Up
- **YELLOW** button : Freeze Teletext
- **BLUE** button : Unfreeze Teletext

※ To exit immediately, press the **TTX** button.

◆ Control PIP channel.

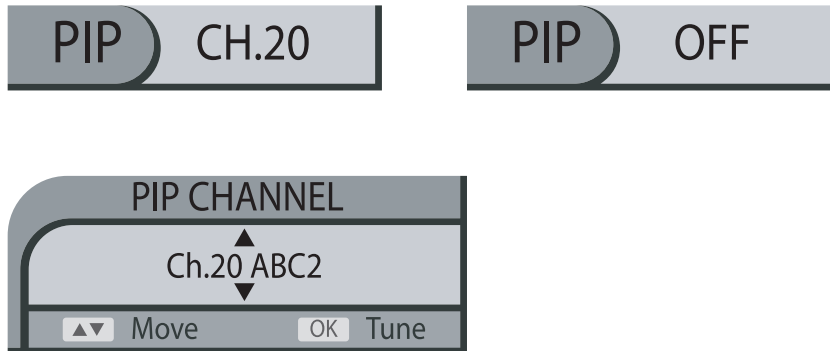

PIP Turn On/Off : Press **PIP ON/OFF** button to turn on or off PIP.

PIP Channel Change : Press **PIP CH** button and PIP channel list is popped up.

PIP Express Channel Up: Keep on pressing **PIP CH** button, when PIP channel OSD is on, then PIP channel move to upside.

PIP Change Position : Press **PIP POS** button to change PIP position.

Swap PIP & Main Video : Press **PIP SWAP** button to swap PIP for Main Program.

❖ To watch the recorded program in PIP, press 'Play in PIP' from Program List or press **PIP SWAP** button after playback at main video.

- ※ While recording a program, PIP window always displays the program under record. And in this case, PIP channel change and SWAP function are unavailable.
- ※ PIP channels can not be changed while recording using Tuner#1.
- ※ Radio Channel is excluded from PIP Channel List.

08 Channel Edit

- ◆ Memorize your choice of channels.

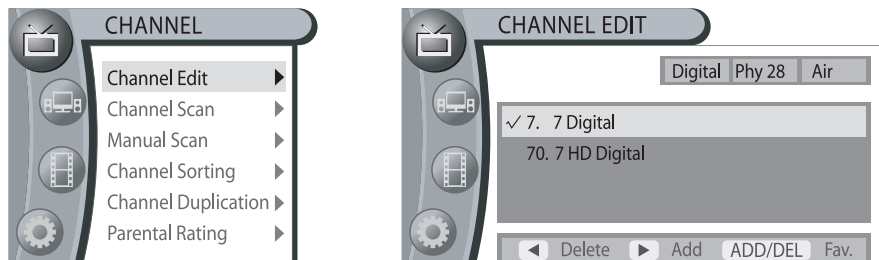

1. Press **MENU** button.
 2. Use ▲, ▼ button to highlight '  ' icon, then press OK.
 3. Press ▲, ▼ button to highlight 'Channel Edit' .
 4. Press OK to tune.
 5. Press ► button to add channels to 'Channel List' or press ◀ button to delete channels to 'Channel List' . If channel is added to 'Channel List' , the colour of the channel number is changed to white. If a channel is deleted from 'Channel List' , the colour of the channel number is changed to black.
 6. Press ADD/DEL button to add a channel to the Favourite Channel List, and press again to delete the channel from the Favourite Channel List. If a channel is added to Favourite Channel List, the colour of the channel number is changed to white and a check is marked in front of the channel number. If a channel is deleted from Favourite Channel List, The check mark as a favourite channel indicator is removed.
- ※ Once Favourite channels are selected, they can be changed by pressing **FAV CH +/-** button.
 - ※ Use **OK** button to make selection.
 - ※ If you change channel in Channel Edit Menu, the timeshift and Tuner #2 recording will be automatically terminated.
 - ※ Press **MENU** button to exit the menu screen.
 - ※ Press **EXIT** button to switch to previous step on the menu screen.

- ◆ Have an automatic channel set up. The Auto Search selects currently available channels.

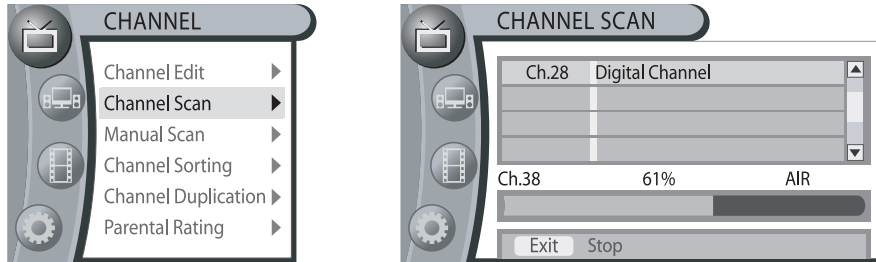



1. Press **MENU** button.
2. Use ▲, ▼ button to highlight ‘’ icon, then press OK.
3. Press ▲, ▼ button to highlight ‘Channel Scan’.
4. The STB will automatically scan and store all of the channels that are available in your local area. (To stop the auto searching, press **EXIT** button.)
5. The scanned channel is displayed when done.
6. It is possible to memorize user’s choice of channels as is done in ‘Channel Edit’ menu or ‘Channel List’.

- ※ If you select the Channel Scan Menu, the timeshift and recording will be automatically terminated.
- ※ Press **MENU** button to exit the menu screen.
- ※ Press **EXIT** button to switch to previous step on the menu screen.

08 Manual Scan

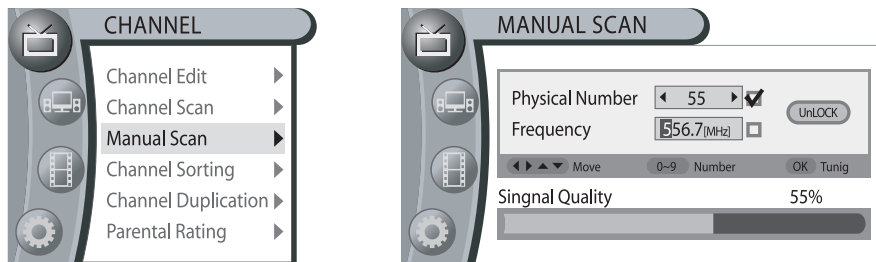
- ◆ Have an manual channel set up.



1. Press **MENU** button.
2. Use ▲, ▼ button to highlight ‘’ icon, then press OK.
3. Use ▲, ▼ button to highlight ‘Manual Scan’, then press OK.
4. Press ◀, ▶ button to select physical channel, or press ‘0’ to ‘9’ button to input channel frequency.
5. Press **OK** button to tune and Memorize channel information.

- ※ After selecting the physical number/frequency, if a signal is received correctly, a message of “LOCK” will be displayed, otherwise “UNLOCK” will be displayed.
- ※ If you select the Manual Scan Menu, the timeshift and recording will be automatically terminated.
- ※ Press **MENU** button to exit the menu screen.
- ※ Press **EXIT** button to switch to previous step on the menu screen.

◆ Select Channel Sorting Method.

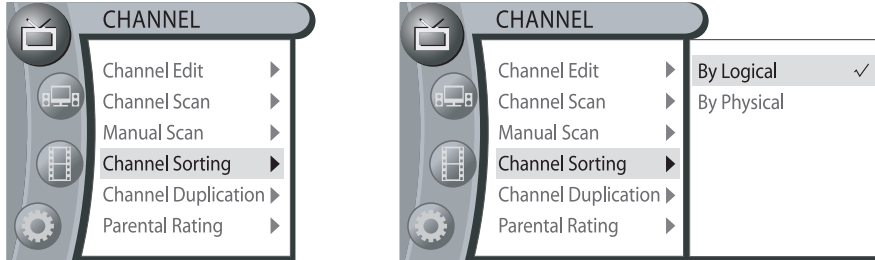



1. Press **MENU** button.
2. Use ▲, ▼ button to highlight '  ' icon, then press OK.
3. Use ▲, ▼ button to highlight 'Channel Sorting' then press OK.
4. Press ▲, ▼ button to make a choice, then press OK.
 - By Logical : 'Channel List' is sorted by logical channel number.
 - By Physical : 'Channel List' is sorted by physical channel number.

- ※ Press **MENU** button to exit the menu screen.
- ※ Press **EXIT** button to switch to previous step on the menu screen.

08 Channel Duplication

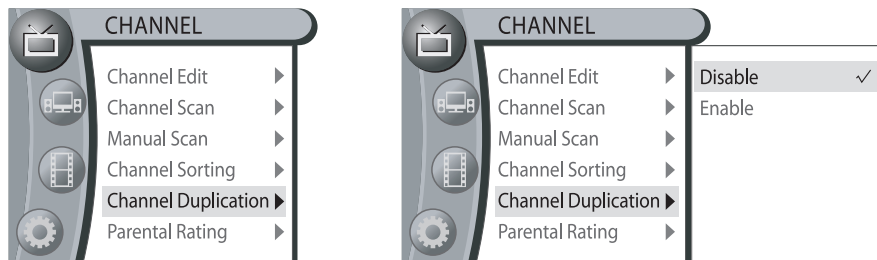
- ◆ Select Channel Duplication Option.



1. Press **MENU** button.
2. Use ▲,▼ button to highlight '  ' icon, then press OK.
3. Use ▲,▼ button to highlight 'Channel Duplication' then press OK.
4. Press ▲,▼ button to make a choice, then press OK.

- ❖ Channel Duplication function is to decide if all the duplicated physical channel for the same logical channel are listed in 'Channel List' or not.

- ❖ When identical logical channel from multiple physical channels are broadcasted, all those physical channels are listed in Channel Edit menu. However, Channel List will show only one physical channel or all those physical channels according to Channel Duplication option.

- ❖ If Channel Duplication Disable is selected, only one superior channel is automatically detected and added in Channel List. The rest of inferior channels are not added in Channel List.

- ❖ If Channel Duplication Enable is selected, all the duplicated physical channel are added in Channel List. In this case there may be repetition of channel number if identical logical channel from multiple physical channels are broadcasted.

- ❖ Though all the rest of inferior physical channels are not added in Channel List by selecting Channel Duplication Enable, you can add any channel that is automatically deleted from Channel List by adding the channel in Channel Edit menu.

- Disable : Show one logical channel in Channel list.
- Enable : Show all the duplicated logical channel in Channel List.

- ※ Press **MENU** button to exit the menu screen.
- ※ Press **EXIT** button to switch to previous step on the menu screen.

◆ Set Parental Guidance Rating.

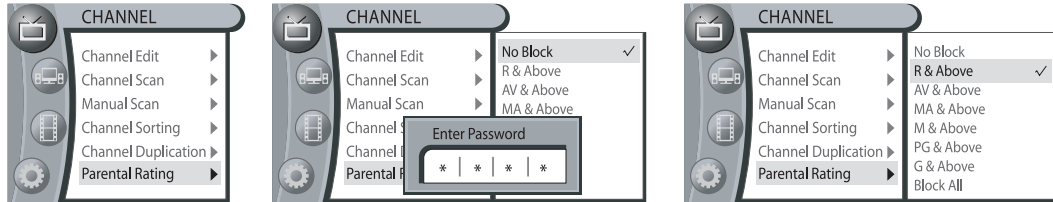

1. Press **MENU** button.
2. Use ▲, ▼ button to highlight ‘’ icon, then press OK
3. Use ▲, ▼ button to highlight ‘Parental Rating’ icon, then press OK.
4. Enter password to proceed.
5. Use ▲, ▼ button to highlight ‘Set’ icon, then press OK.
6. Use ▲, ▼ button to make a choice from the rating levels, then press OK.
 - No Block
 - R & Above
 - AV & Above
 - MA & Above
 - M & Above
 - PG & Above
 - G & Above
 - Block All

❖ The factory default password is 0 – 0 – 0 – 0.

❖ For any reason, if you forget the password, Press **MENU, CC, 3,6,9** button sequentially, then the password will be back to ‘0000’ again.

※ Press **MENU** button to exit the menu screen.

※ Press **EXIT** button to switch to previous step on the menu screen.

❖ Control HDMI video output.



1. Press **MENU** button.
2. Use ▲, ▼ button to highlight '  ' icon, then press OK.
3. Use ▲, ▼ button to highlight 'HDMI Video', then press OK.
4. Press ▲, ▼ button to make a choice, then press OK.

HDMI means the value of video timing is setup for HDMI

- ❖ It will take a few seconds to set HDMI video mode, if mode selection is changed from HDMI to YPbPr/RGB or vice versa.
- ❖ HDMI mode supports HDMI1080i, HDMI720p, HDMI576p, 1080i, 720p, 576p, and 576i . One of the above seven output video formats can be selected by **V.FORMAT** button. In HDMI mode, HDMI1080i, HDMI720p, and HDMI576p are shown in Status (by pressing the **MARK** button) as H1080i, H720p, and H576p, respectively.

YPbPr/RGB means the value of video timing is setup for YPbPr/RGB

- ❖ YPbPr/RGB mode supports 1080i, 720p, 576p, and 576i. One of the above four output video formats can be selected by **V.FORMAT** button.
- ❖ If display device works well by receiving HDMI signal from NHD-3000PVR in YPbPr, RGB video mode, you may use the HDMI video output without changing to HDMI mode.

- ※ Press **MENU** button to exit the menu screen.
- ※ Press **EXIT** button to switch to previous step on the menu screen.

◆ Control HDMI audio output.



1. Press **MENU** button.
2. Use ▲, ▼ button to highlight ‘’ icon, then press OK.
3. Use ▲, ▼ button to highlight ‘HDMI Audio’, then press OK.
4. Press ▲, ▼ button to make a choice, then press OK.
 - Auto : If the broadcaster is broadcasting PCM/MPEG, the Digital OUT will be PCM. If the broadcaster is broadcasting Dolby Digital, the Digital OUT will be Dolby Digital.
 - PCM : Whatever the broadcaster is broadcasting (PCM/MPEG or Dolby Digital), the Digital OUT will be at PCM.
 - DISABLE : Select this, in order to have Digital Audio OUT in Dolby Digital for using external amplifier at below conditions.
 - The TV digital audio support only PCM, and HDMI cable is used.
 - The broadcaster is broadcasting Dolby Digital.

❖ When you connect using HDMI cable, the digital audio in the TV is detected. So if it detects PCM, then the Digital OUT will be at PCM too. If it detects Dolby Digital, then the Digital OUT will be at Dolby Digital too.

- ※ Press **MENU** button to exit the menu screen.
- ※ Press **EXIT** button to switch to previous step on the menu screen.

09 Monitor Setup

◆ Adjust display position.



1. Press **MENU** button.
2. Use ▲, ▼ button to highlight '  ' icon, then press OK.
3. Use ▲, ▼ button to highlight 'Monitor Setup', then press OK.
4. Customize the Monitor type to fit user's TV or display.
 - 16 : 9
 - 4 : 3

- ※ Press **MENU** button to exit the menu screen.
- ※ Press **EXIT** button to switch to previous step on the menu screen.

◆ Controls audio output type.



1. Press **MENU** button.
2. Use ▲, ▼ button to highlight ‘’ icon, then press OK.
3. Use ▲, ▼ button to highlight ‘Digital Audio Out.’, then press OK.
4. Use ▲, ▼ button to make a choice, then press OK.
 - PCM : Digital Audio Output is always PCM.
 - Dolby D : Digital Audio Output is Dolby Digital in case of Dolby Digital audio stream come in.

- ※ Press **MENU** button to exit the menu screen.
- ※ Press **EXIT** button to switch to previous step on the menu screen.

09 PIP Size

❑ Set up the PIP size.



1. Press **MENU** button.
2. Use ▲, ▼ button to highlight '  ' icon, then press OK.
3. Use ▲, ▼ button to highlight 'PIP Size', then press OK.
4. Press ▲, ▼, ◀, ▶ button to make a choice, then press OK.
 - PIP size can be chosen from 'Large', 'Medium', or 'Small'.

- ※ Press **MENU** button to exit the menu screen.
- ※ Press **EXIT** button to switch to previous step on the menu screen.

- ◆ Turn on and off the remote controller volume control functionality.





1. Press **MENU** button.
2. Use ▲, ▼ button to highlight '  ' icon, then press OK.
3. Use ▲, ▼ button to highlight 'Vol. Control' , then press OK.
4. Use ▲, ▼ button to make a choice, then press OK.
 - OFF : Volume of the STB can NOT be controlled by remote control.
 - ON : Volume of the STB can be controlled by remote control.

- ※ When the volume is off, the **MUTE** button will operate as normal. However you will not be able to control volume.
- ※ Press **MENU** button to exit the menu screen.
- ※ Press **EXIT** button to switch to previous step on the menu screen.

10 Program List

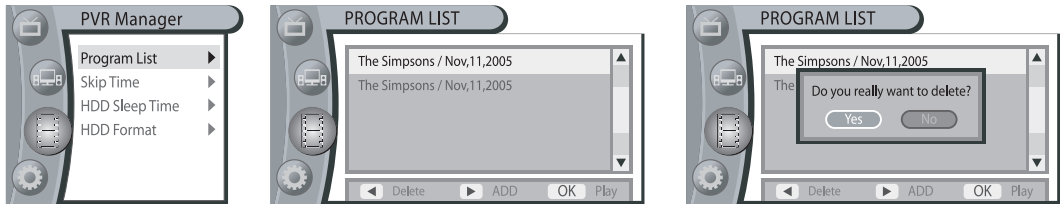
- ❖ The Program List shows the recorded programs.
(You can also bring up the Program List by pressing the **P.LIST** button on the remote control.)



1. Press **MENU** button.
2. Use ▲, ▼ button to highlight '  ' icon, then press OK.
3. Use ▲, ▼ button to highlight 'Program List', then press OK.
4. On the Program List, press ◀, ▶ button to select a program.
5. Press **OK** button to playback the selected program.
6. Press ◀ button to delete the selected program.
7. Press ▶ button to add the selected program.

- ※ The selected program for deleting will be erased when exit the program list menu. The program can be added again only before erased.
- ※ If you play any program in Program List Menu, the timeshift will be automatically terminated.
- ※ Press **MENU** button to exit the menu screen.
- ※ Press **EXIT** button to switch to previous step on the menu screen.

◆ Set up how much time will be skipped when user press **SKIP+**, **SKIP-** button.

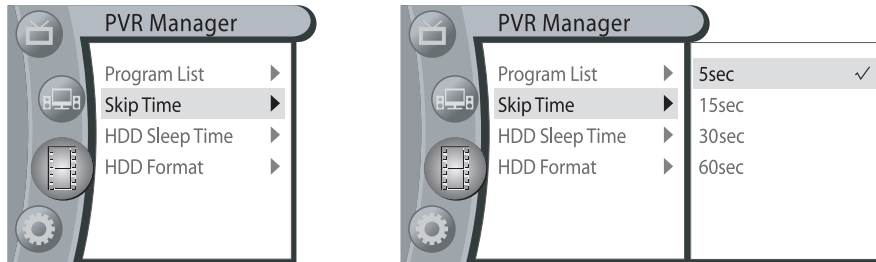



1. Press **MENU** button.
2. Use ▲, ▼ button to highlight '  ' icon, then press OK.
3. Use ▲, ▼ button to highlight 'Skip Time', then press OK.
4. Press ▲, ▼ button to make a choice, then press OK.

- ※ Press **MENU** button to exit the menu screen.
- ※ Press **EXIT** button to switch to previous step on the menu screen.

10 HDD Sleep Time

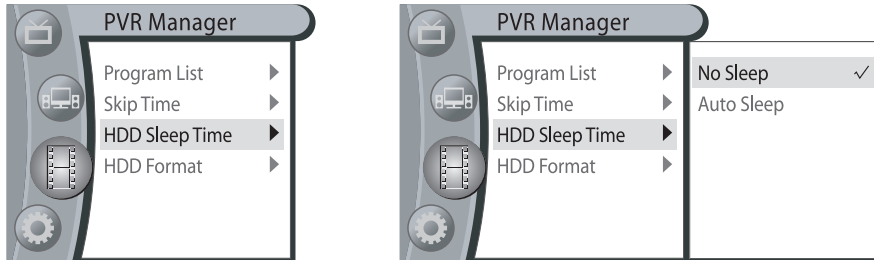
- ❑ Set up how much time the HDD will be powered on after the HDD has no works to do.



1. Press **MENU** button.
2. Use ▲, ▼ button to highlight '  ' icon, then press OK.
3. Use ▲, ▼ button to highlight 'HDD Sleep Time', then press OK.
4. Press ▲, ▼ button to make a choice, then press OK.

- ※ In HDD Auto Sleep mode, if HDD is not used for 3 minutes, the HDD will enter into sleep mode. When you want to use HDD again, it will take 2 or 3 seconds to escape from HDD sleep mode.
- ※ Press **MENU** button to exit the menu screen.
- ※ Press **EXIT** button to switch to previous step on the menu screen.

◆ Formats the HDD. All the recorded programs will be deleted.

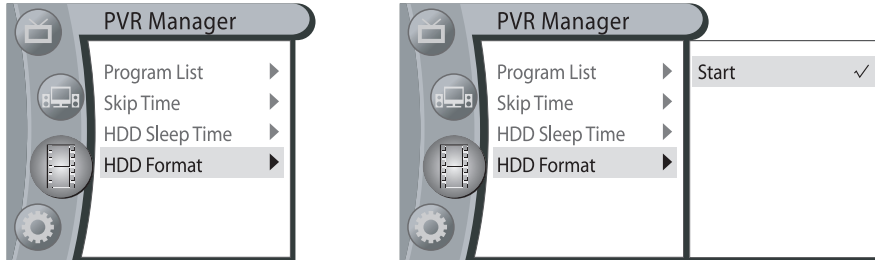

1. Press **MENU** button.
2. Use ▲, ▼ button to highlight ‘’ icon, then press OK.
3. Use ▲, ▼ button to highlight ‘HDD Format’, then press OK.
4. Enter password to proceed.
5. Press OK to start HDD format.

Caution

If you format the HDD, everything recorded on the HDD will be erased.

- ※ The factory default password is 0 – 0 – 0 – 0.
- ※ For any reason, if you forget the password, Press **MENU, CC, 3,6,9** button sequentially, then the password will be back to ‘0000’ again.
- ※ Press **MENU** button to exit the menu screen.
- ※ Press **EXIT** button to switch to previous step on the menu screen.

11 Opacity

❖ Control opacity (transparent) of menu screen.



1. Press **MENU** button.
2. Use ▲, ▼ button to highlight '  ' icon, then press OK.
3. Use ▲, ▼ button to highlight 'Opacity', then press OK.
4. Press ▲, ▼ button to make a choice, then press OK.
 - Opacity1 : Very Dark
 - Opacity2 : Dark
 - Opacity3 : Light
 - Opacity4 : Very Light

- ※ Press **MENU** button to exit the menu screen.
- ※ Press **EXIT** button to switch to previous step on the menu screen.

◆ Select time zone.



1. Press **MENU** button.
2. Use ▲, ▼ button to highlight ‘’ icon, then press OK.
3. Use ▲, ▼ button to highlight ‘Time Zone’ , then press OK.
4. Use ▲, ▼ button to make a choice, then press OK.
 - NSW/ACT
 - VIC/TAS
 - QLD
 - SA
 - WA
 - NT
 - Auto Time Zone

- ※ If the automatic clock setting is not correct, go to the channel that broadcasting teletext and press **TTX** button.
- ※ Press **MENU** button to exit the menu screen.
- ※ Press **EXIT** button to switch to previous step on the menu screen.

11 Daylight Saving

◆ Select daylight saving.



1. Press **MENU** button.
2. Use ▲, ▼ button to highlight '  ' icon, then press OK.
3. Use ▲, ▼ button to highlight 'Daylight Saving', then press OK.
4. Use ▲, ▼ button to make a choice, then press OK.
 - Off : Daylight Saving is off.
 - On : Daylight Saving is on.

- ※ If you select 'Auto time Zone', Daylight Saving On/Off does not work.
- ※ If the automatic clock setting is not correct, go to the channel that broadcasts teletext and press **TTX** button.
- ※ Press **MENU** button to exit the menu screen.
- ※ Press **EXIT** button to switch to previous step on the menu screen.

- ◆ Select the time in which the unit is to be turned off.





1. Press **MENU** button.
2. Use ▲, ▼ button to highlight '⚙️' icon, then press OK.
3. Use ▲, ▼ button to highlight 'Sleep Timer', then press OK.
4. Use ▲, ▼ button to make a choice, then press OK.

- ※ Press **MENU** button to exit the menu screen.
- ※ Press **EXIT** button to switch to previous step on the menu screen.

11 New Password

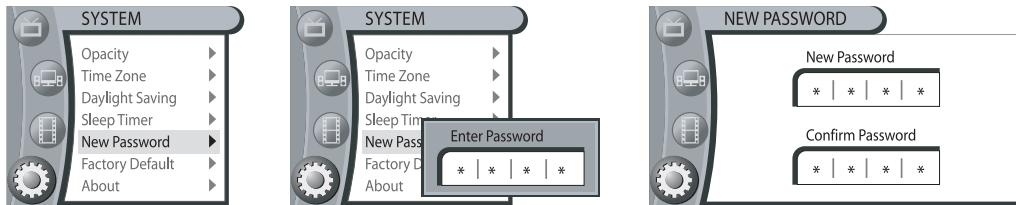
◆ Change the 4-digit password.



1. Press **MENU** button.
2. Use ▲, ▼ button to highlight '  ' icon, then press OK.
3. Use ▲, ▼ button to highlight 'NEW PASSWORD' icon, then press OK.
4. Enter password to proceed.
5. Enter new password and make a confirmation using number keys on the remote controller.

- ※ The factory default password is 0-0-0-0.
- ※ For any reason, if you forget the password, Press **MENU, CC, 3,6,9** button sequentially, then the password will be back to '0000' again.
- ※ When the program rating exceeds the level set on this menu, you will see the OSD above and audio and video will be blocked. Enter password to watch the program. The pass state will be valid until power is off.
- ※ Press **MENU** button to exit the menu screen.
- ※ Press **EXIT** button to switch to previous step on the menu screen.

◆ Set Factory Default.

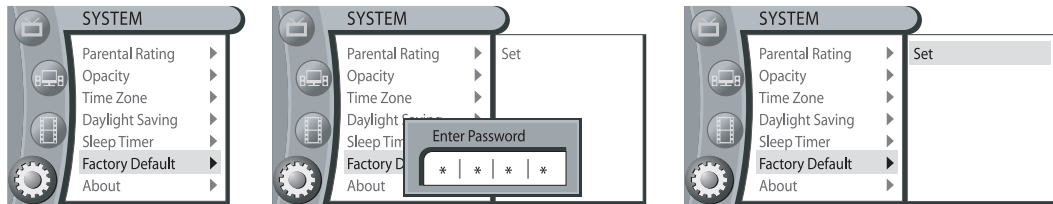



1. Press **MENU** button.
2. Use ▲, ▼ button to highlight '  ' icon, then press OK
3. Use ▲, ▼ button to select Factory Default, then press OK.
4. Enter password to proceed.
5. Press **OK** button to set to Factory Default.

- ※ The factory default password is 0-0-0-0.
- ※ For any reason, if you forget the password, Press **MENU, CC, 3,6,9** button sequentially, then the password will be back to '0000' again.
- ※ Set to Factory Default takes 25 second.
- ※ Don't Power Off during set to Factory Default.
- ※ Press **MENU** button to exit the menu screen.
- ※ Press **EXIT** button to switch to previous step on the menu screen.

11 About

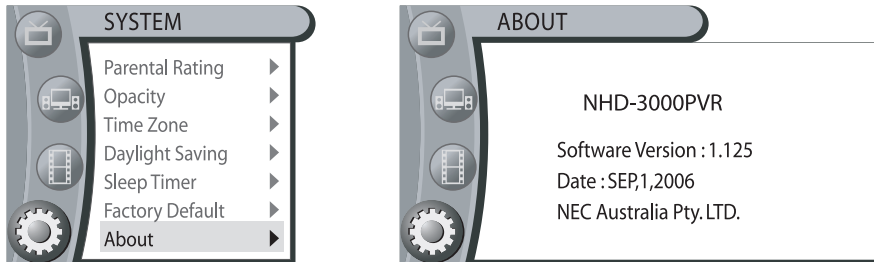
- ◆ Show the software version and date.



1. Press **MENU** button.
2. Use ▲, ▼ button to highlight '  ' icon, then press OK.
3. Use ▲, ▼ button to highlight 'About' , then press OK.
4. Use ▲, ▼ button to make a choice, then press OK.

- ※ Press **MENU** button to exit the menu screen.
- ※ Press **EXIT** button to switch to previous step on the menu screen.

ITEM	SPECIFICATIONS
Product Name	High Definition Receiver / Recorder
Model	NHD-3000PVR
Supply Voltage	AC 240V, 50Hz
Power Consumption	Operation : 25W max, Standby : 1W max
Size (W X H X D)	335mm x 65mm x 270mm
Weight (Kg)	NET : 3.0 Kg, GROSS : 4.2 Kg
Channel	Band-III(137-230MHz), Band-IV(519-820MHz)
Antenna Impedance	75Ω
Input/Output (NHD-3000PVR)	Antenna input 2ea & Loop Output 2ea Component (Y, Pb, Pr) Output 1set HDMI/DVI Output 1ea RGB/HV Output 1ea S-Video Output 1ea Composite Output 1ea Digital Audio Output (Optical) 1ea Digital Audio Output (Coaxial) 1ea Analog Audio Output (L/R) 2 sets Service Port (RS232-C) 1ea

NEC

NEC Australia Pty. Ltd.
ABN 86 001 217 527
DISPLAY AND HOME GROUP

NEC Service Centres

New South Wales

Sydney	184 Milperra Rd, Revesby 2212	131-632
Newcastle	120 Parry Street, Newcastle West 2302	131-632

Victoria

Melbourne	Unit 1/6, Garden Road, Clayton, 3168	131-632
-----------	--------------------------------------	---------

Queensland

Brisbane	Unit 4/305 Montague road, West End, 4101	131-632
Southport	Shop 1, 48 Ferry Road, Southport 4215	131-632

South Australia

Adelaide	84A Richmond Rd, Keswick, 5053	131-632
----------	--------------------------------	---------

Western Australia

Perth	45 Sarich Court, Osborne Park 6017	131-632
-------	------------------------------------	---------

For Service in outer areas, please contact your NEC retailer for the address of the nearest Authorised NEC Service Centre.

NEC Australia Pty. LTD.
DISPLAY AND HOME GROUP
244 Beecroft Road EPPING 2121
Tel: 131-632
Fax: (02) 9877 2353



NEC